



# Drill & Learn **WORKBENCH™**

Project Guide





# Level 1



001

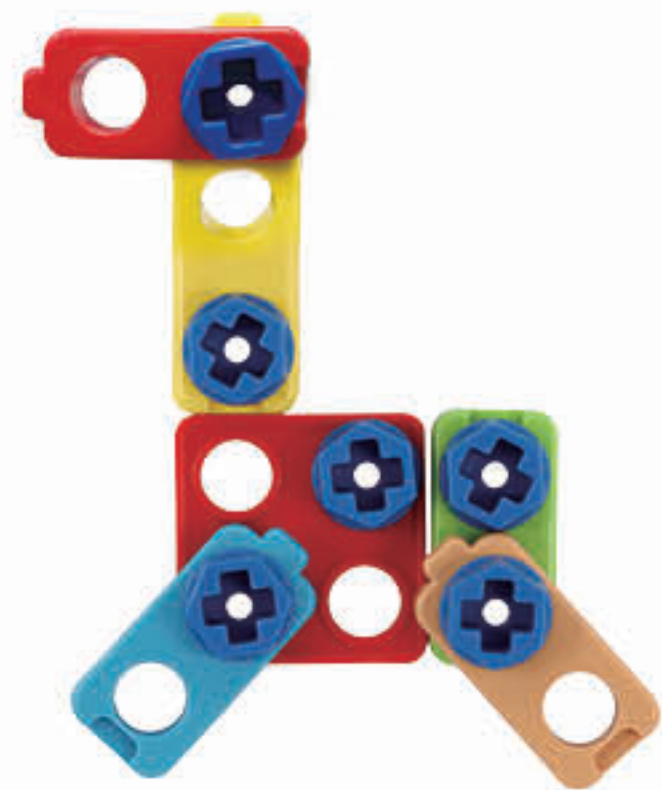

002

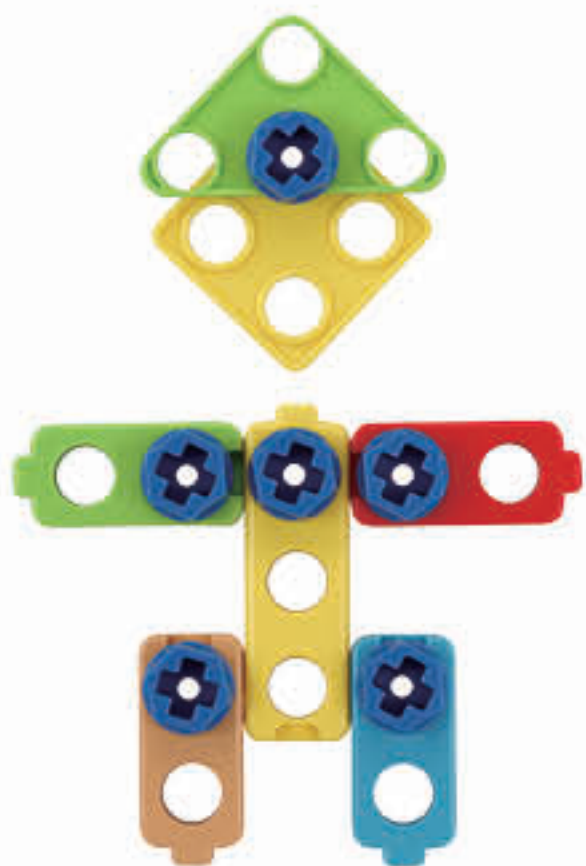

003

Online Only

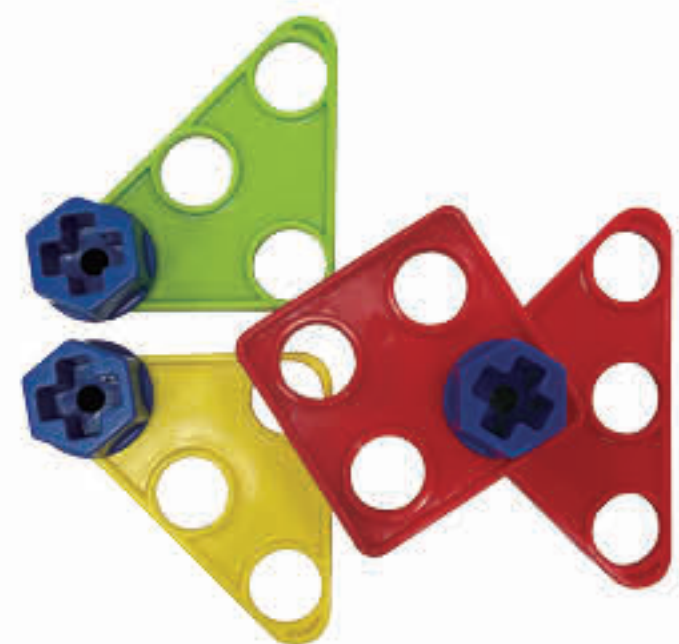

004

Online Only



005



# Level 2

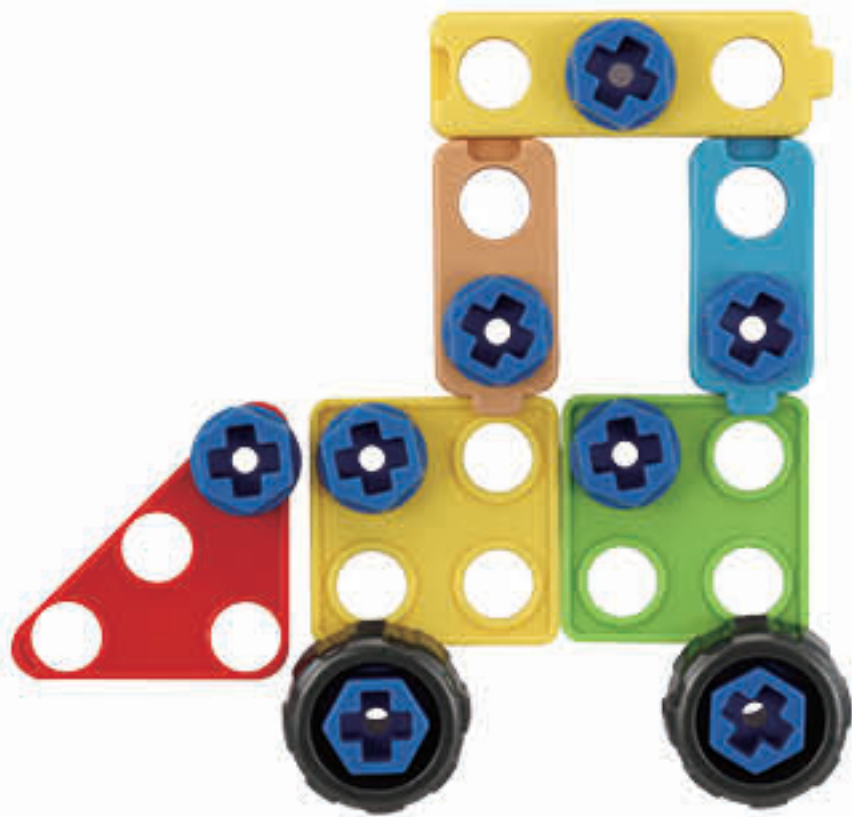

006

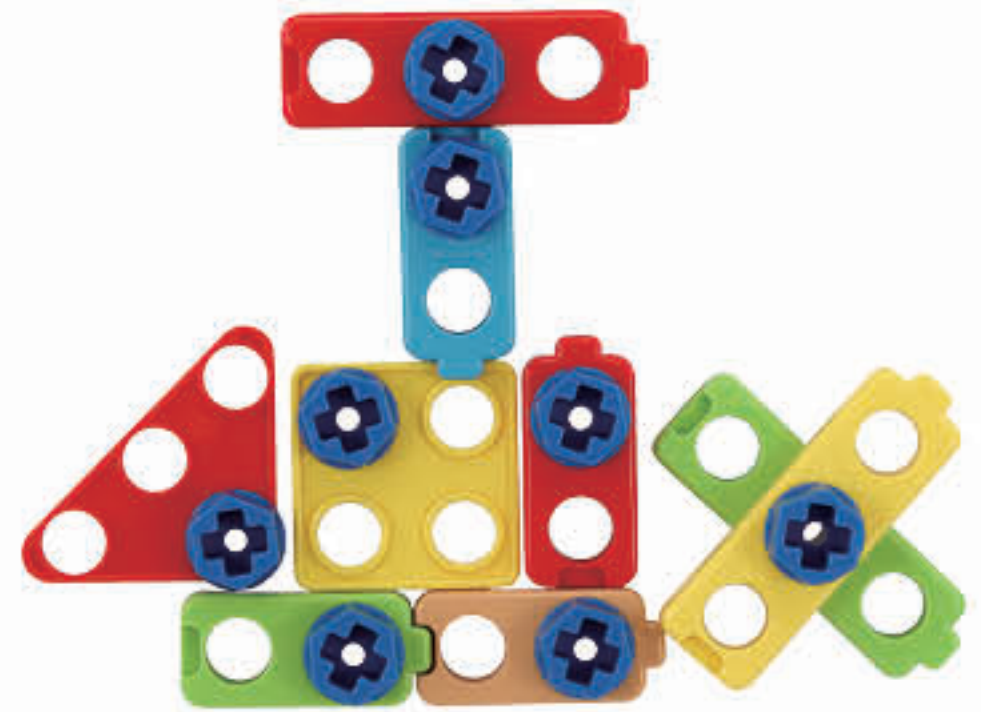

007

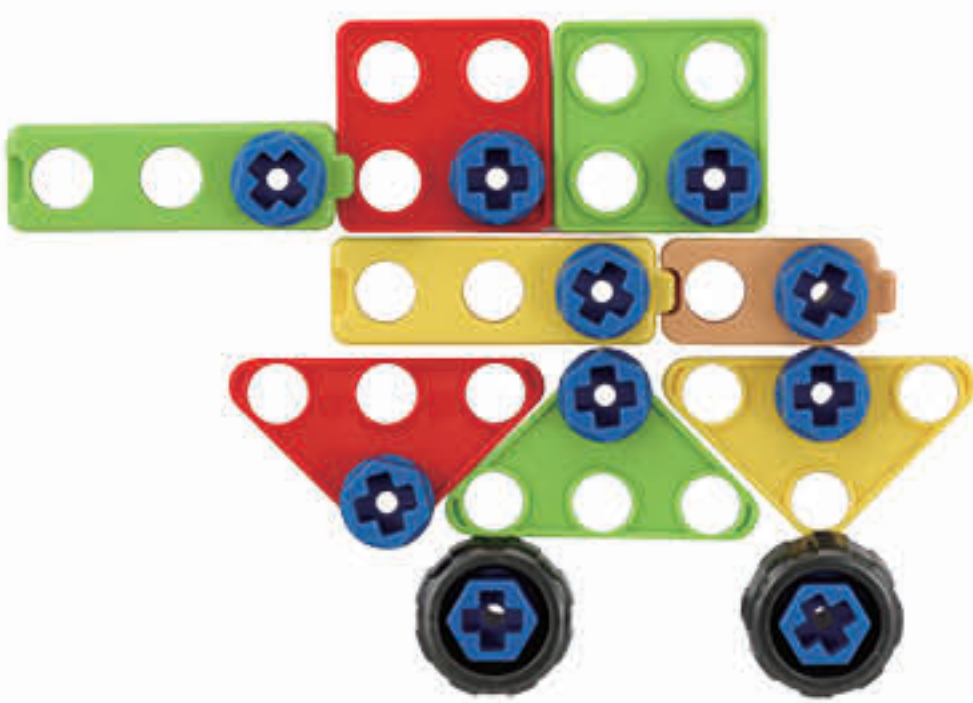

008

Online Only



009

Online Only

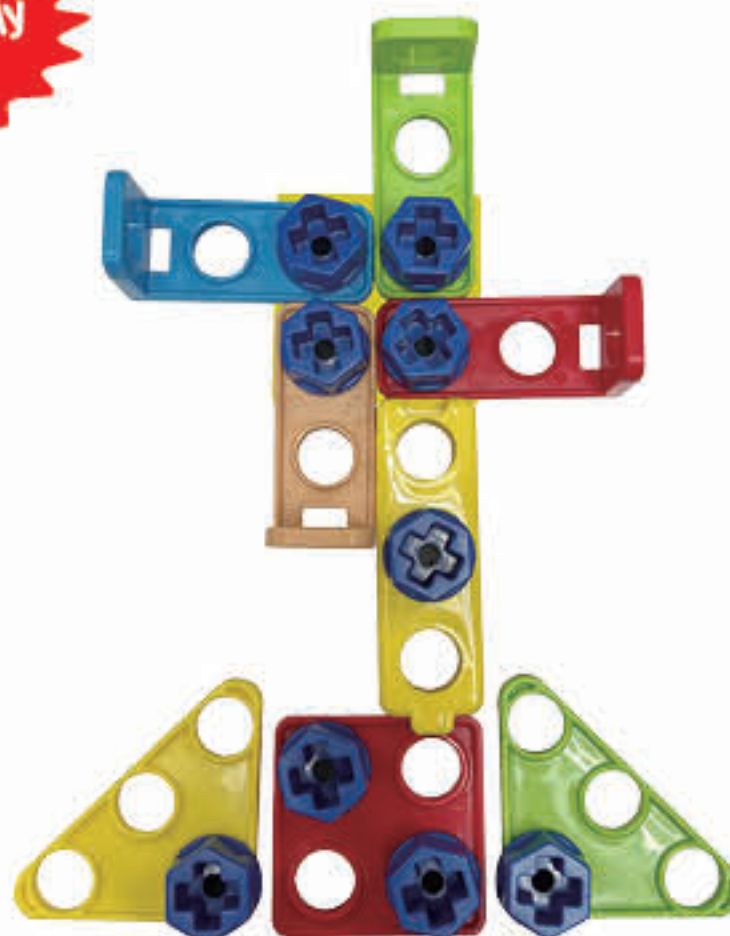

010



# Level 3



011



012



013



014



015



# Level 1

001

x1 x1

x1 x3

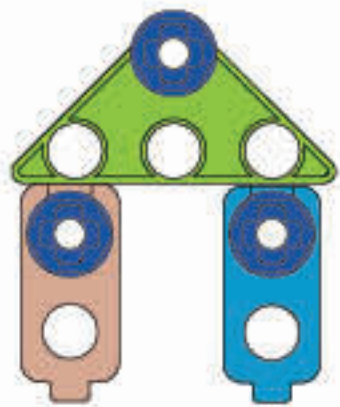

1

x1 x1 x1  
x3

Top View

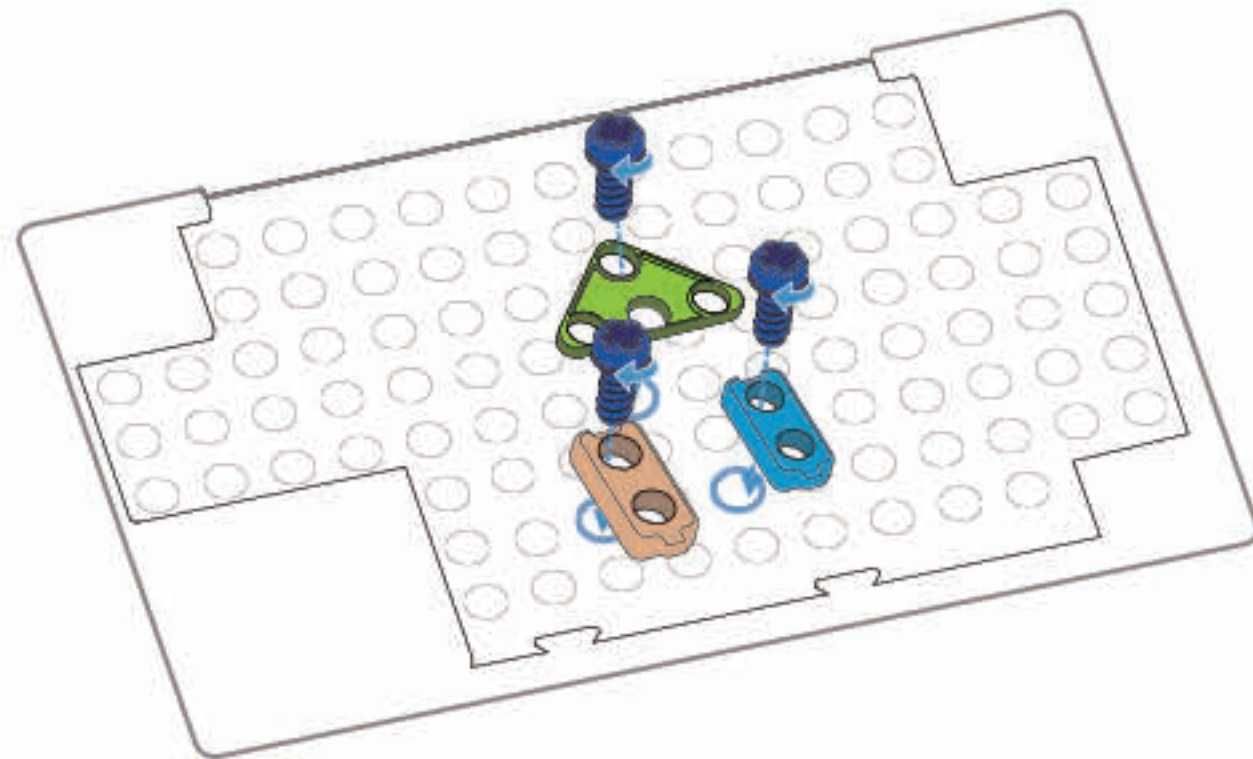

Well done!  
You made it!



002

x1

x1 x1

x1 x1

x1 x6

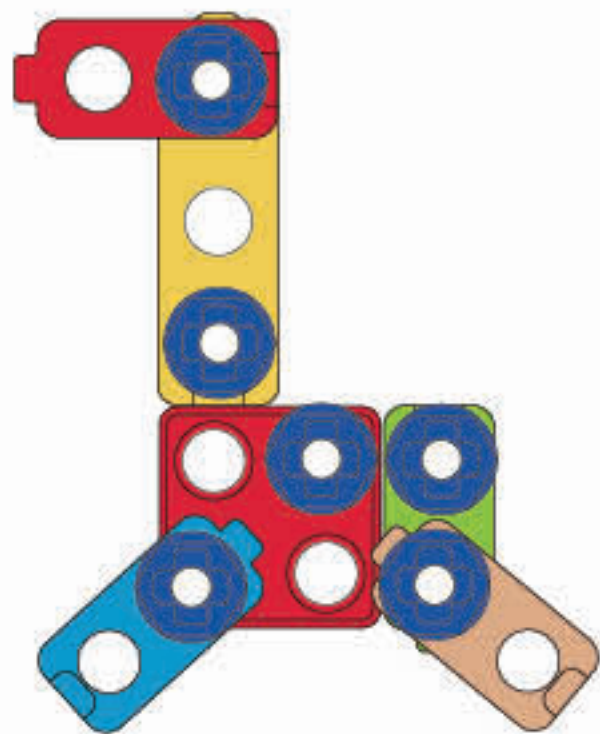

1

x1 x1  
x3 x1

Top View

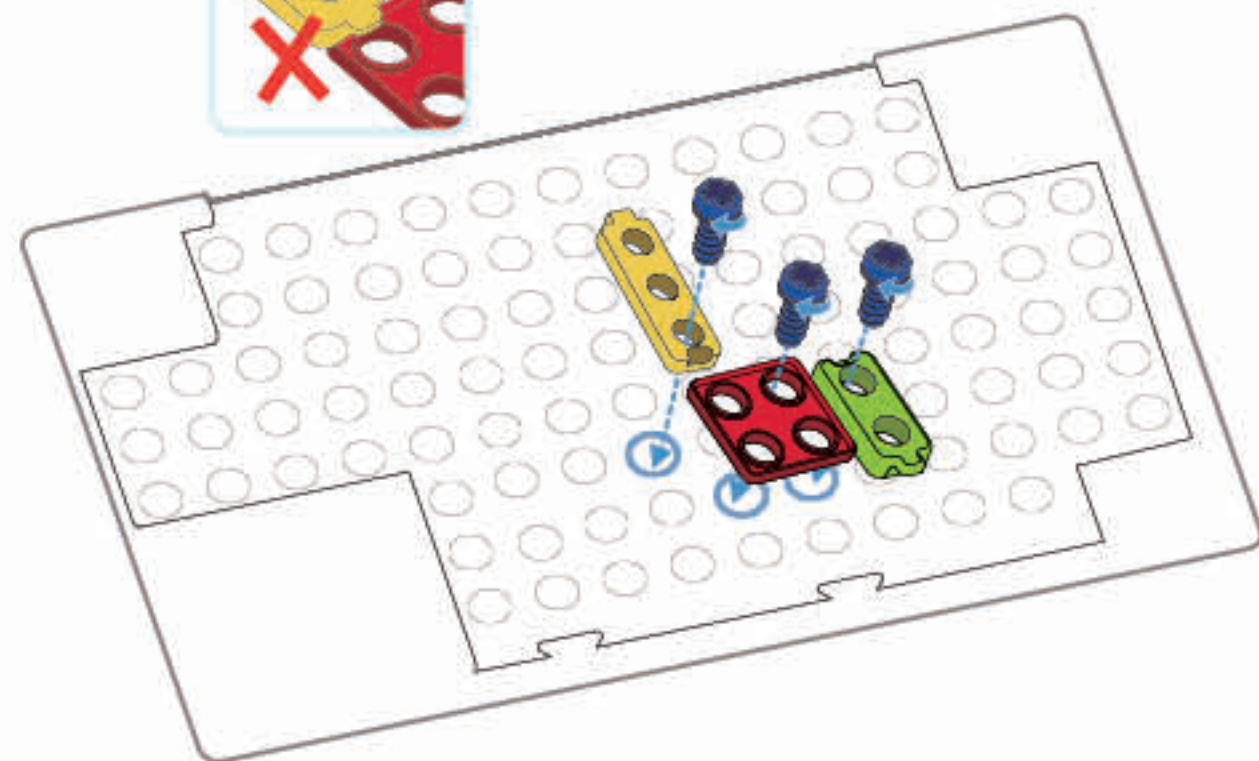

Well done!  
You made it!



2

x1 x1  
x1 x3

Top View

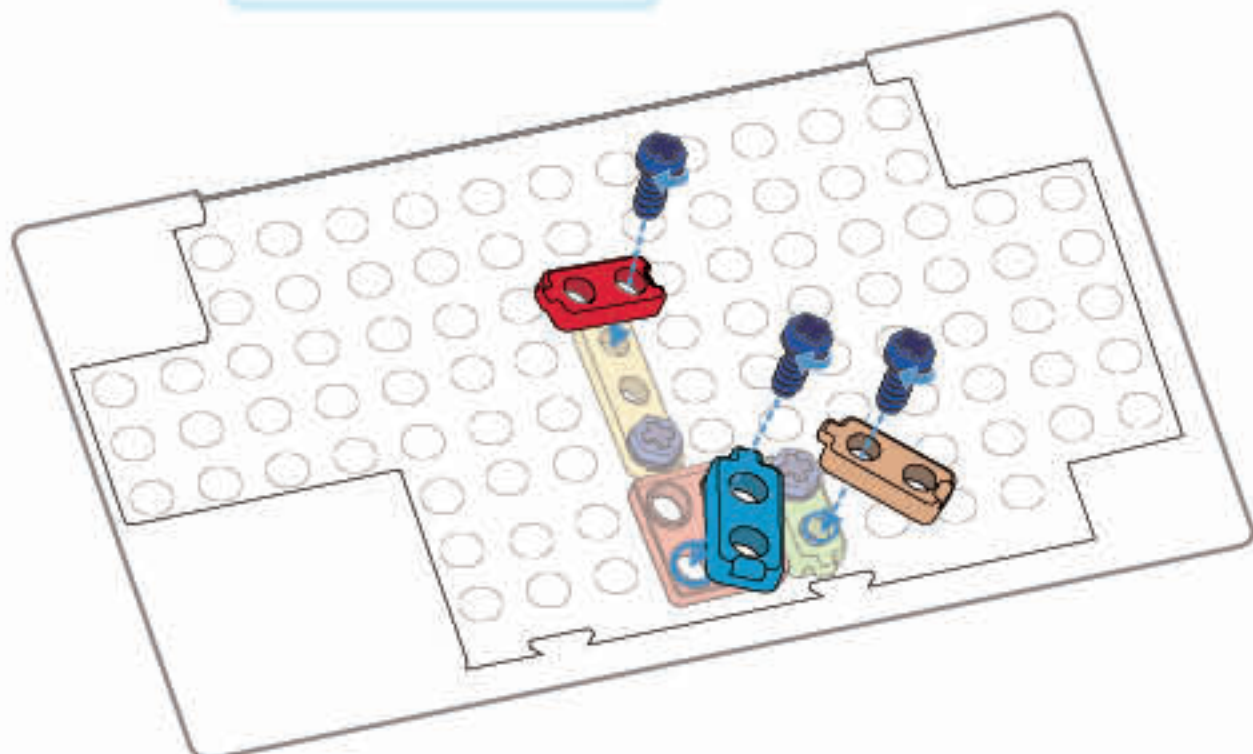



003

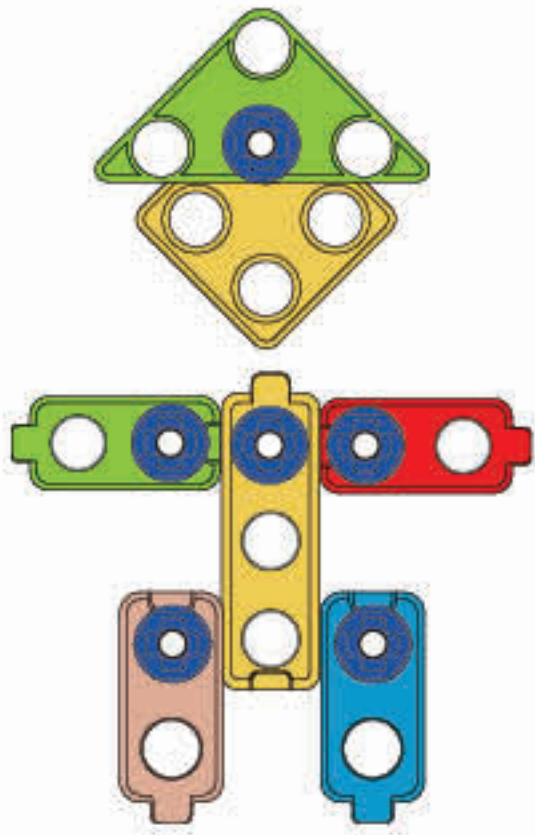
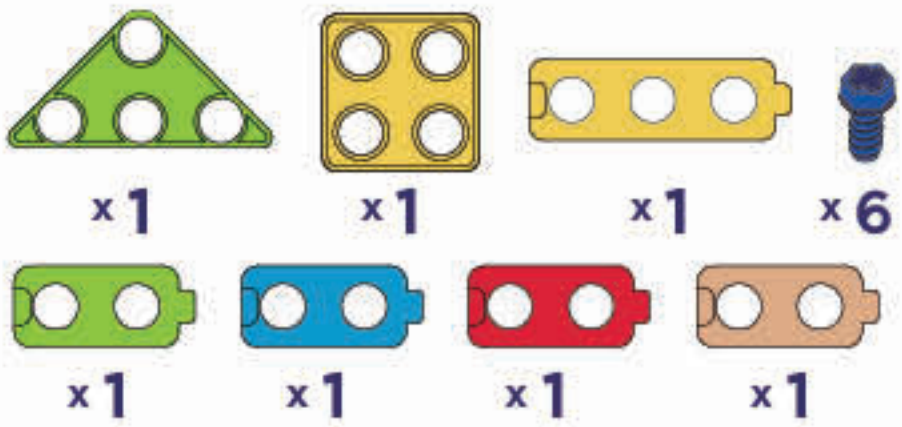

1

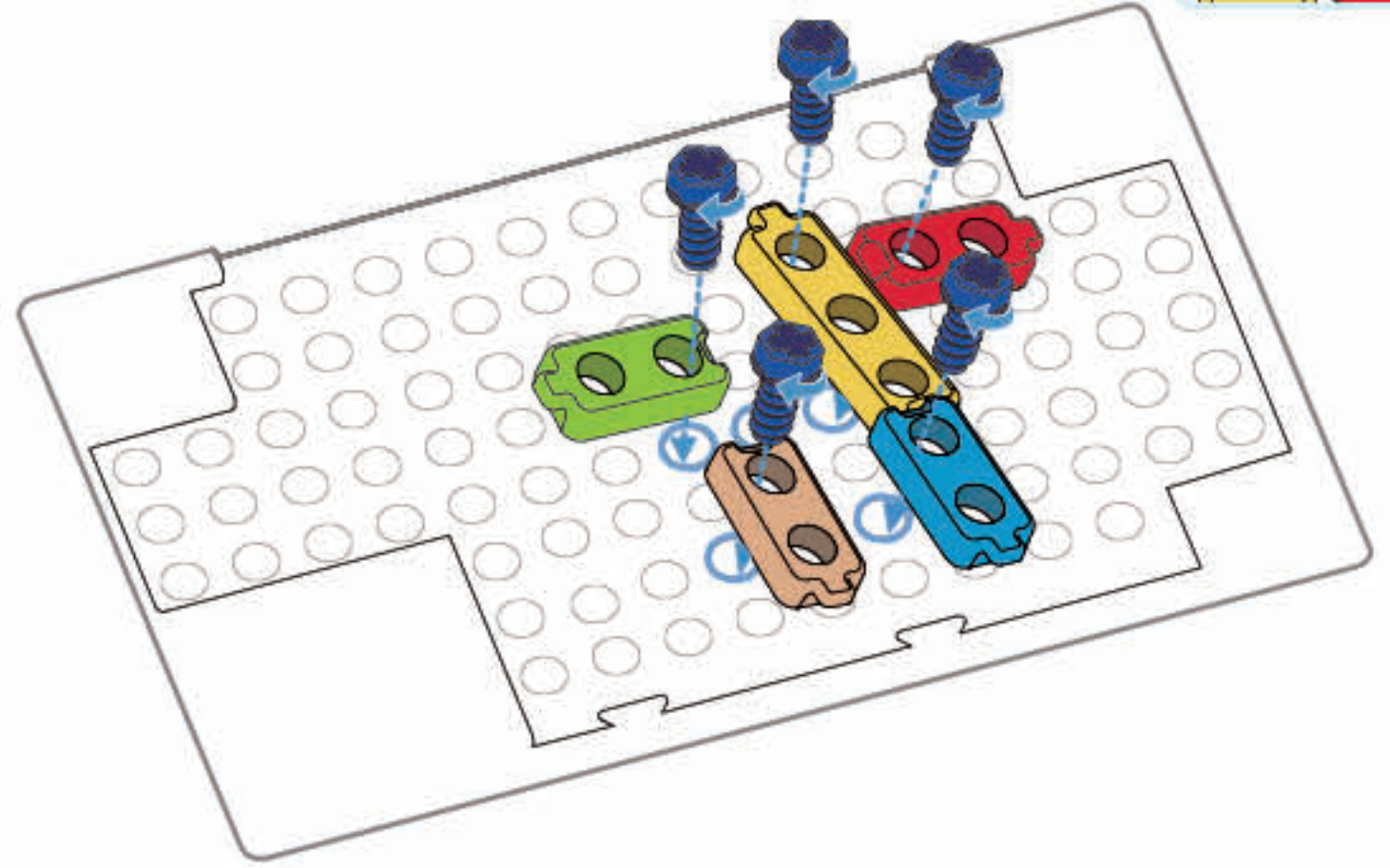
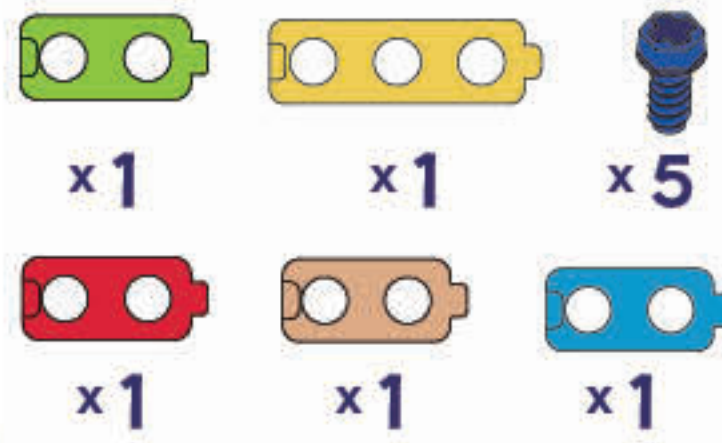

2

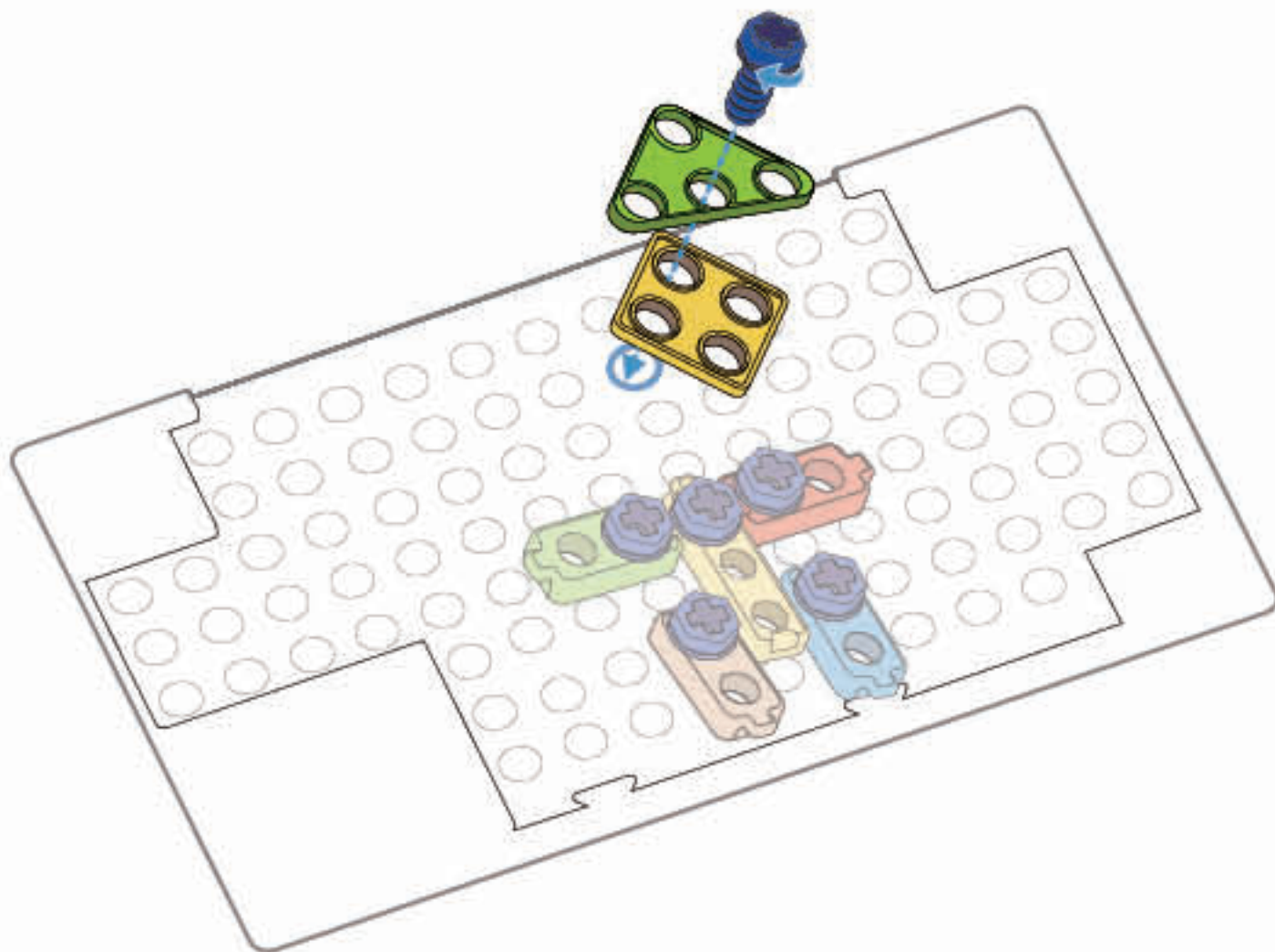
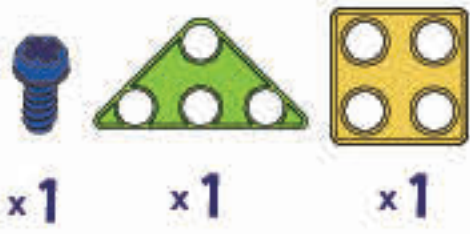

Well done!  
You made it!

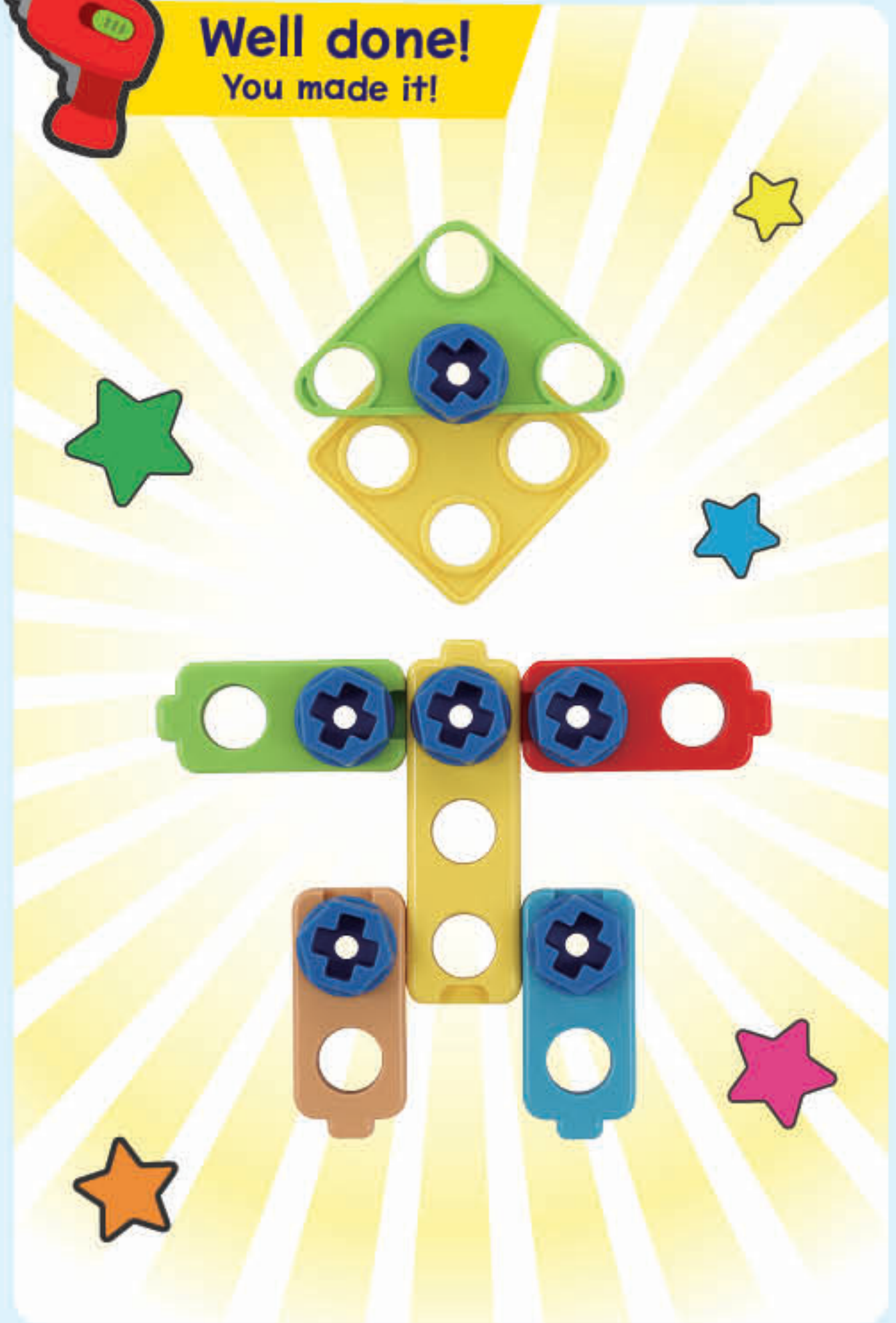



004

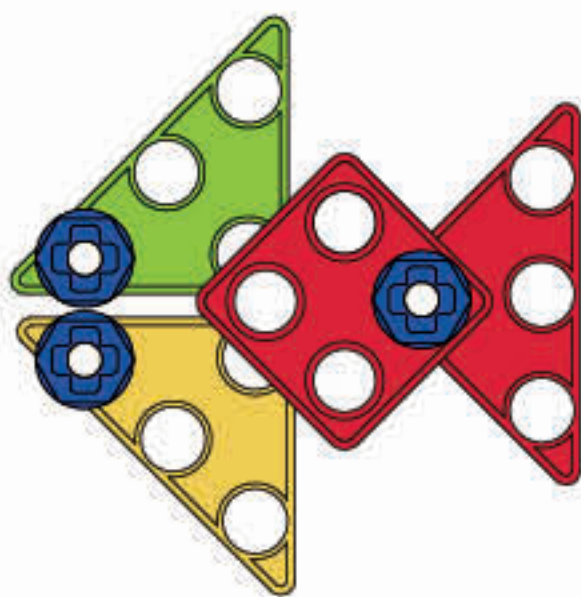
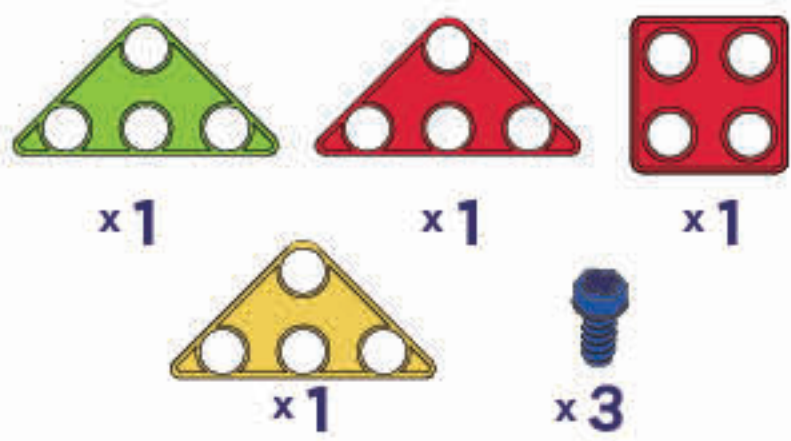

1

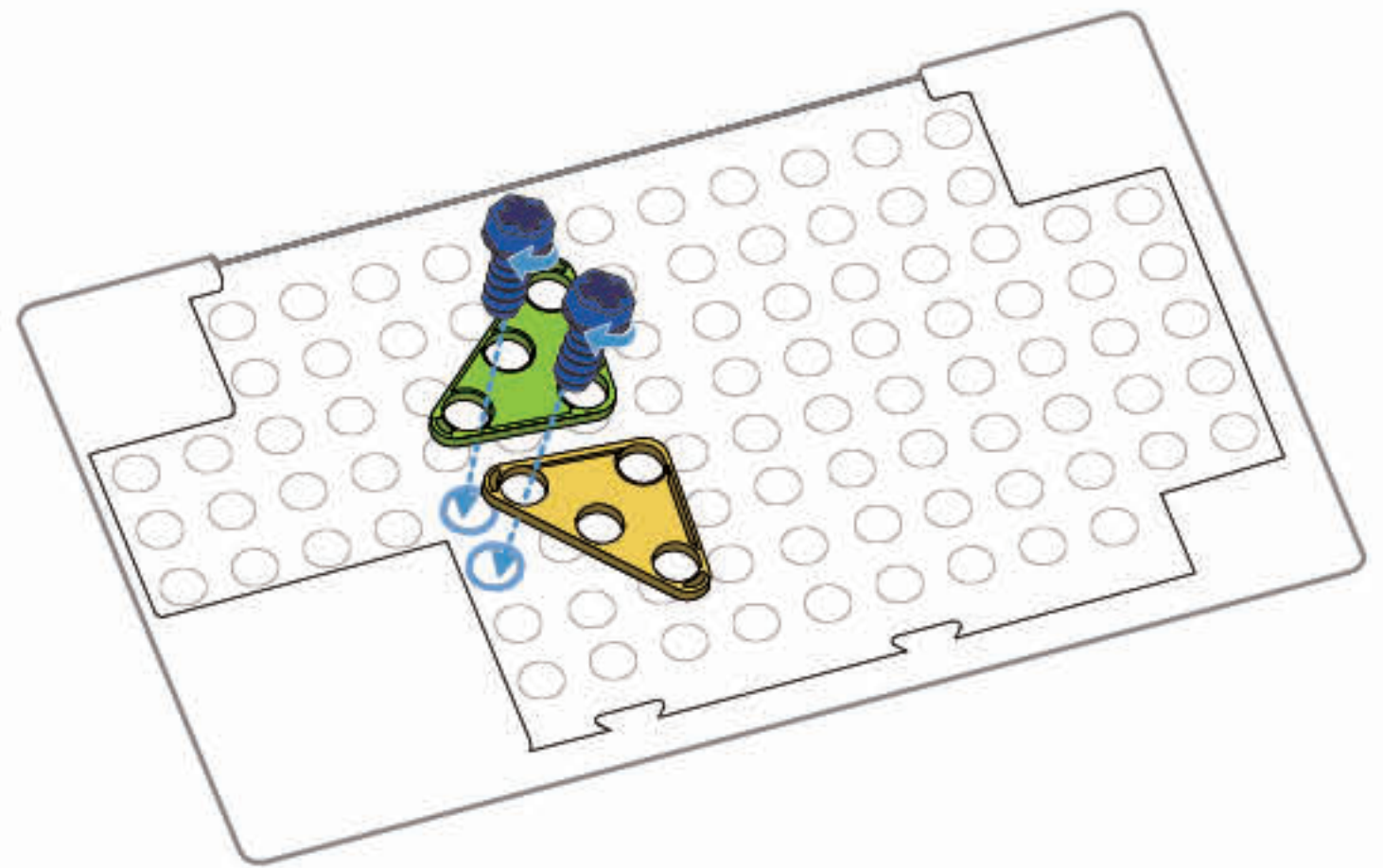
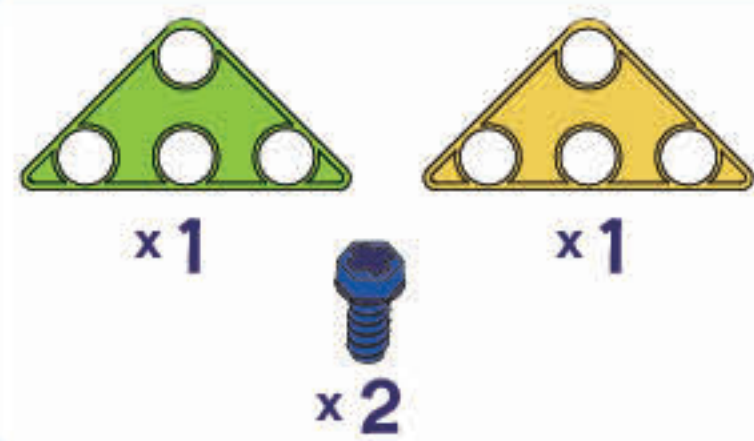

2

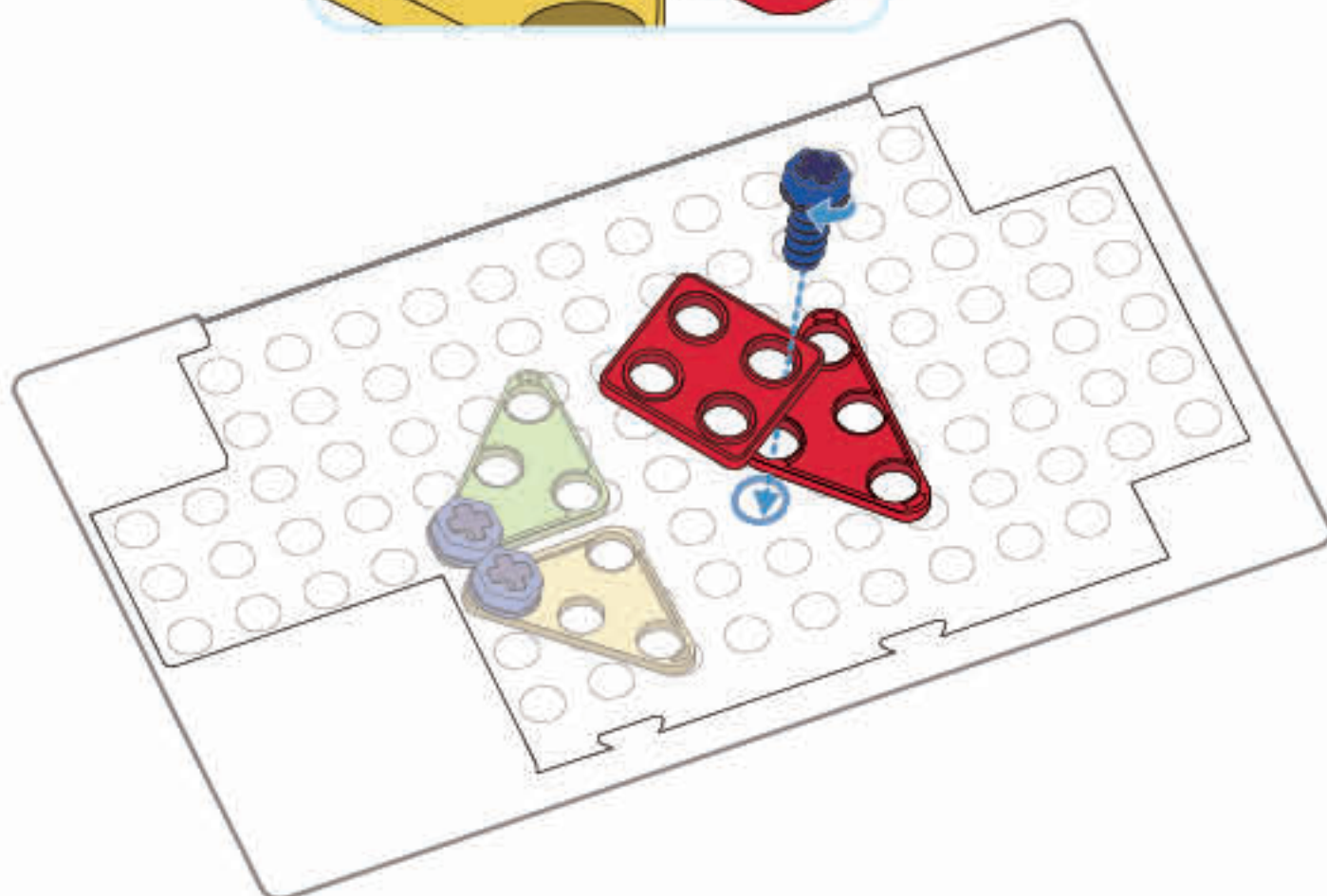
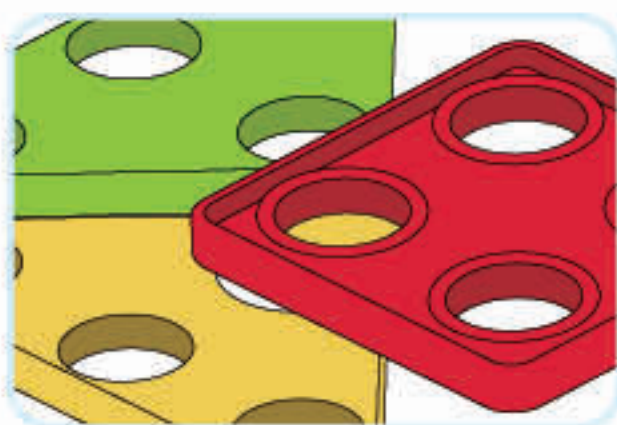
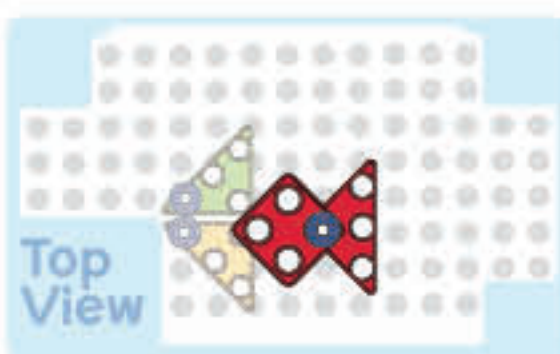
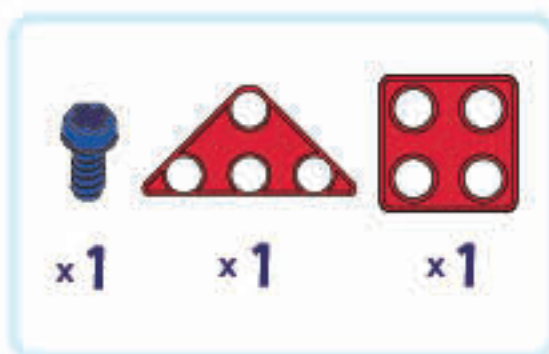

**Well done!**  
You made it!

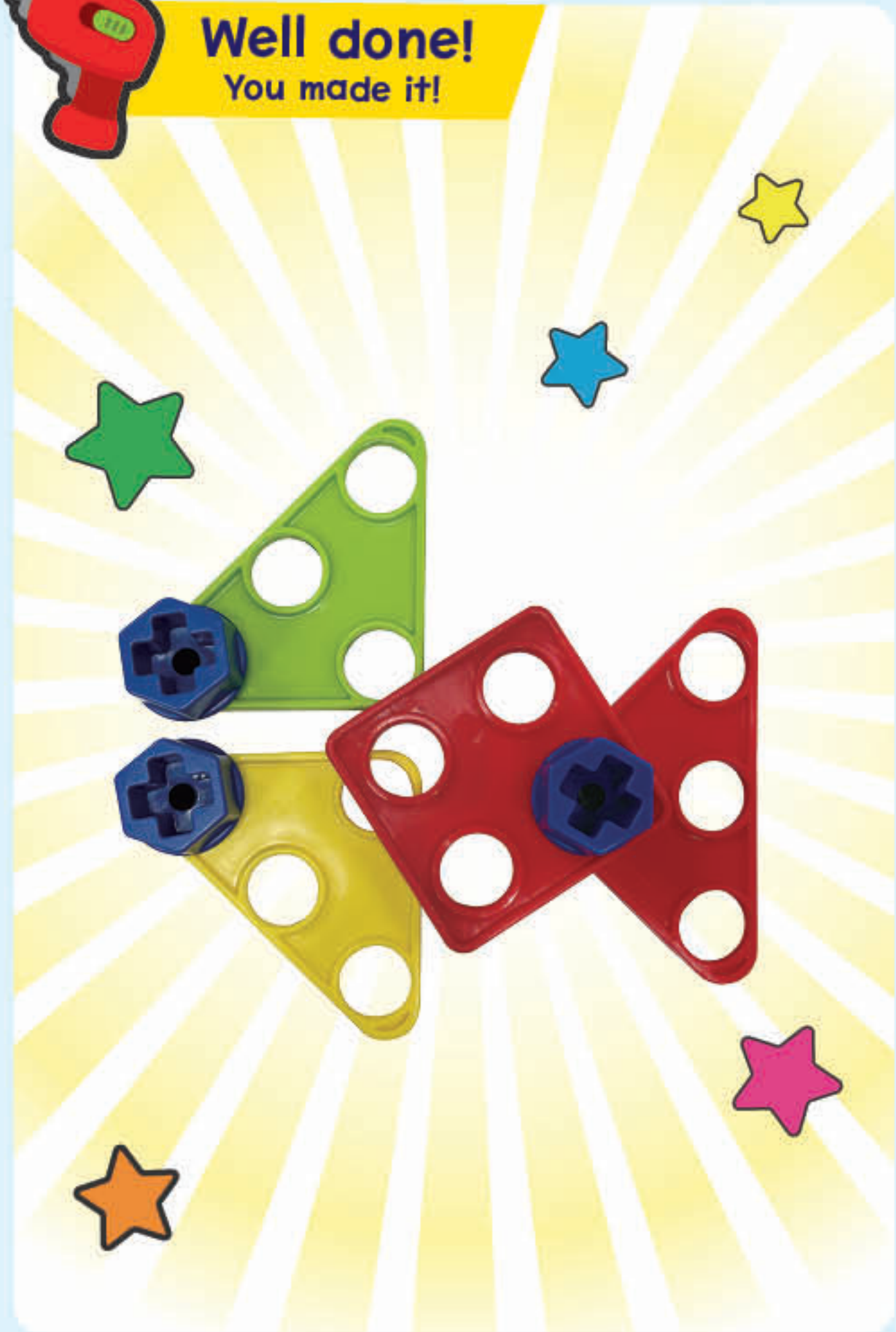



005

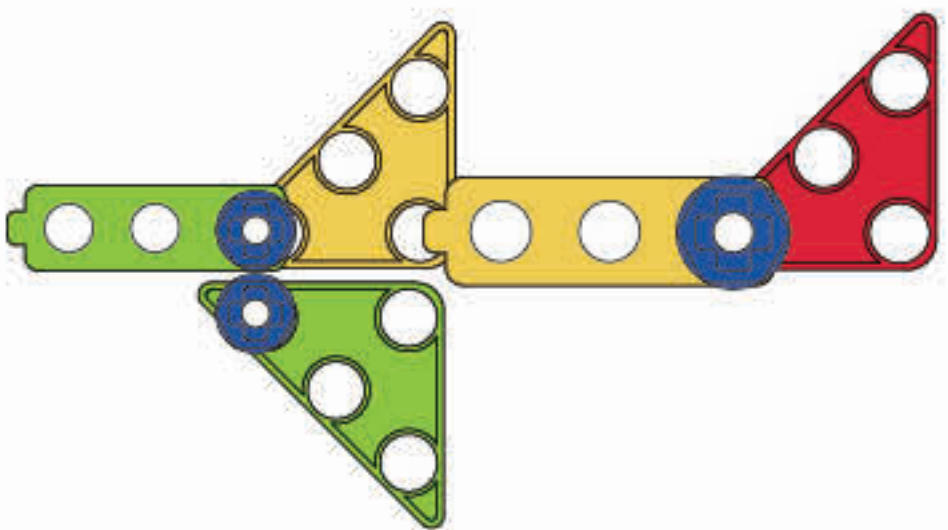
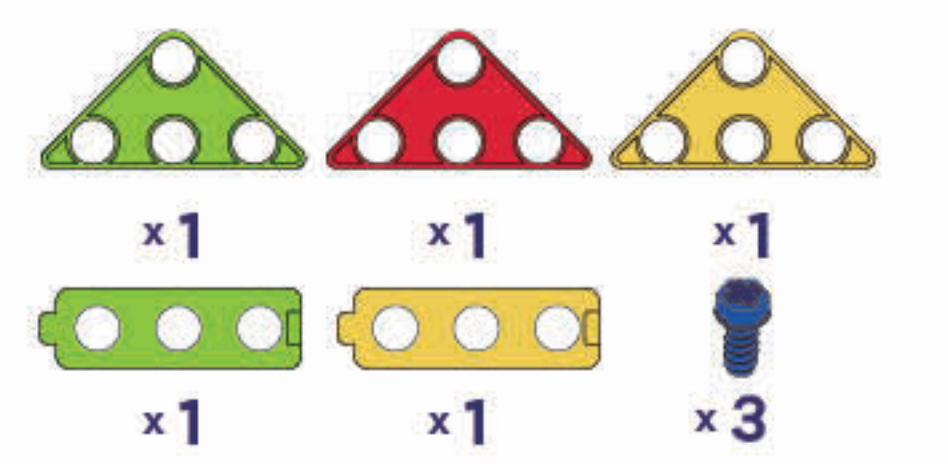

1

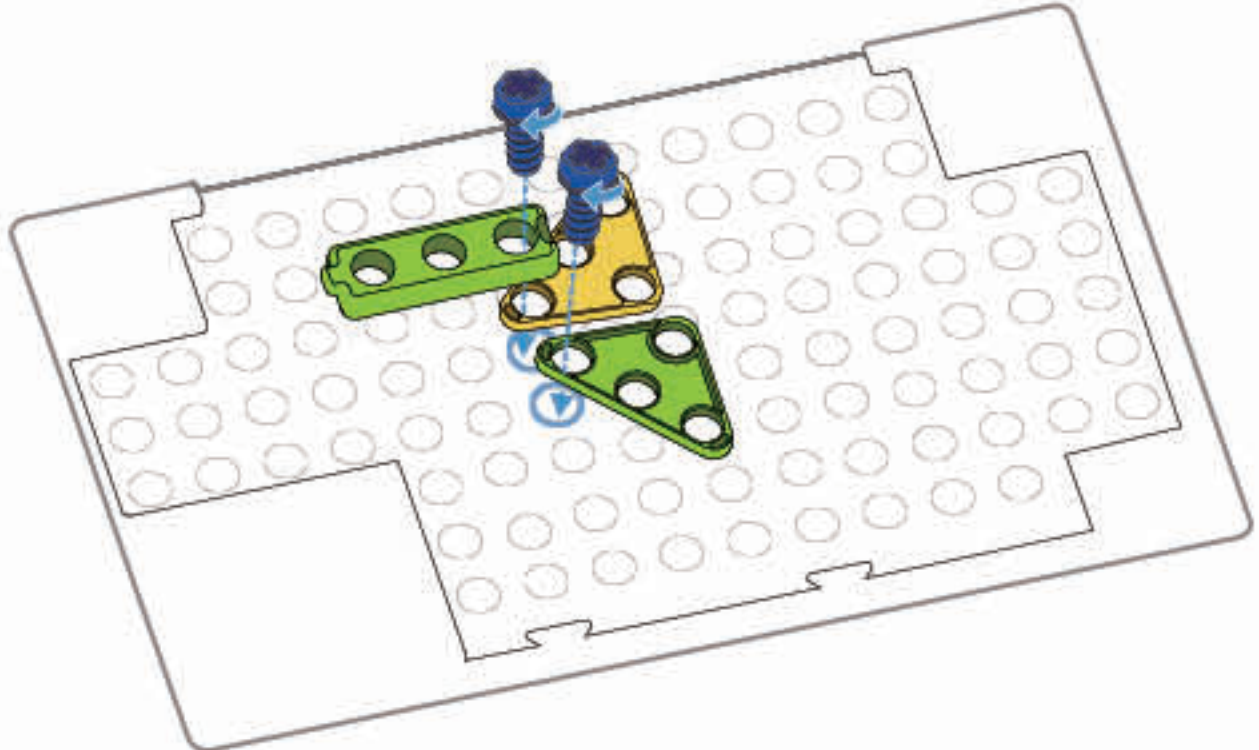
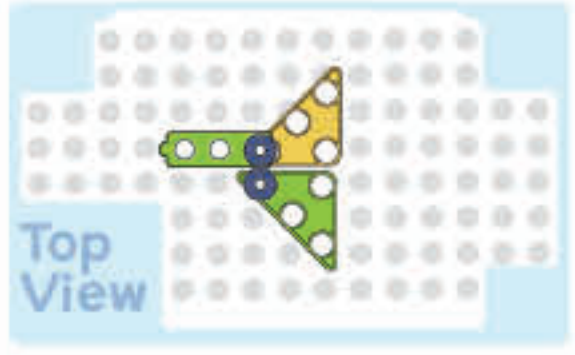
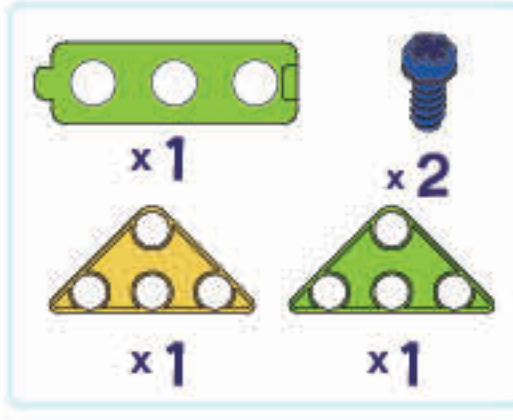

2

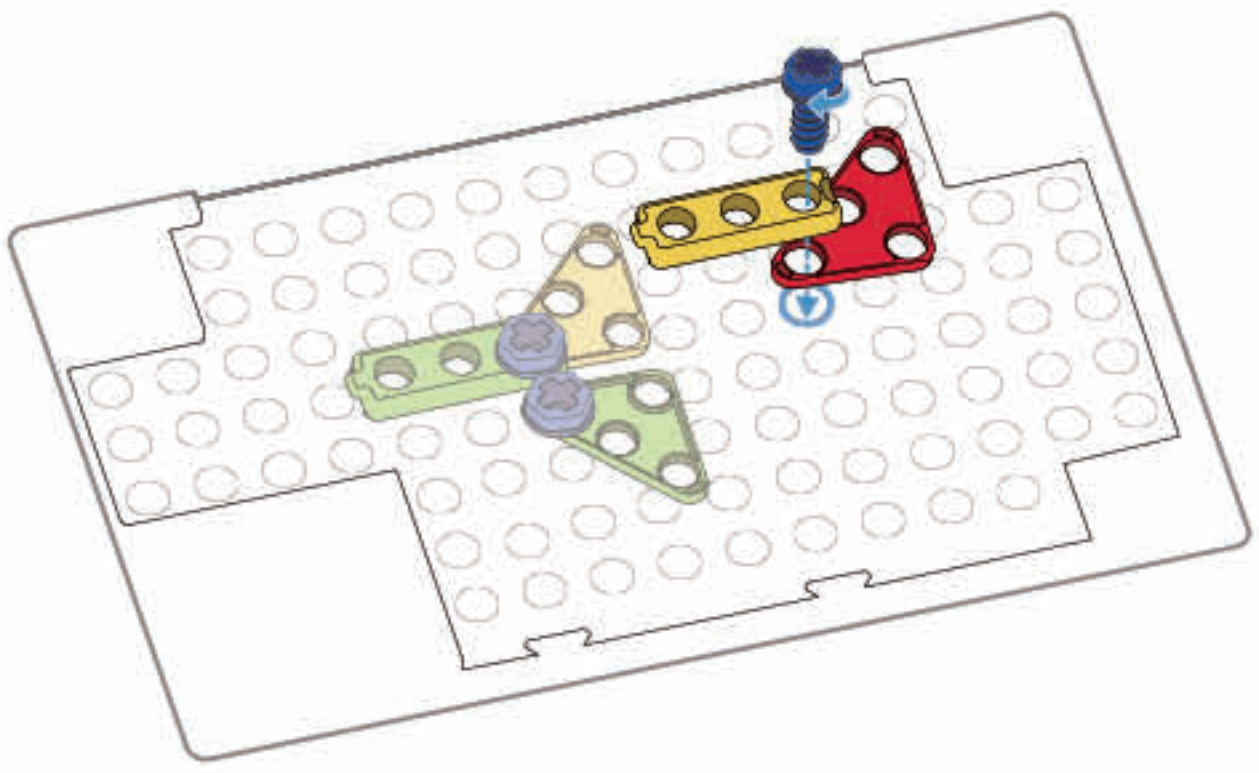
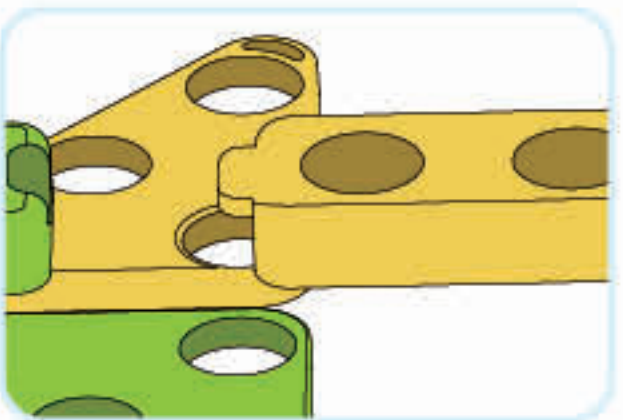
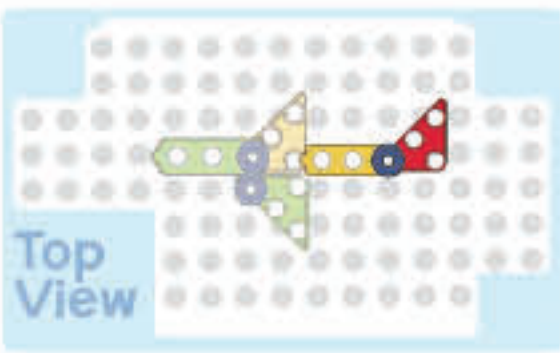
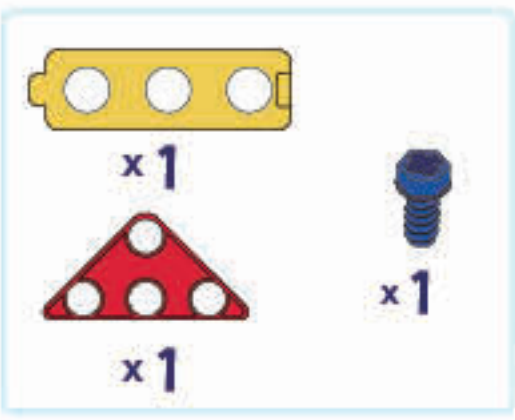

**Well done!**  
You made it!

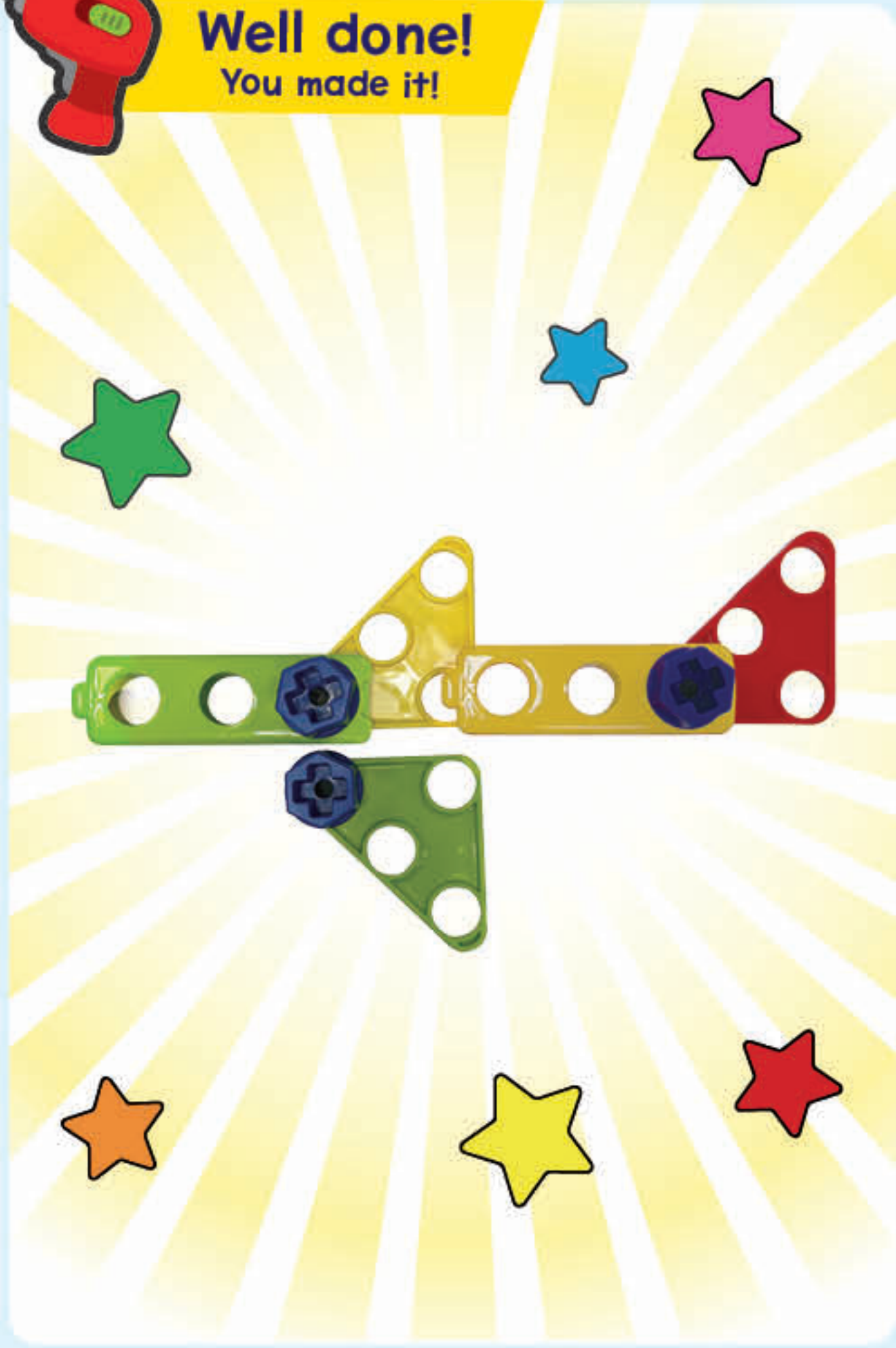



# Level 2

006

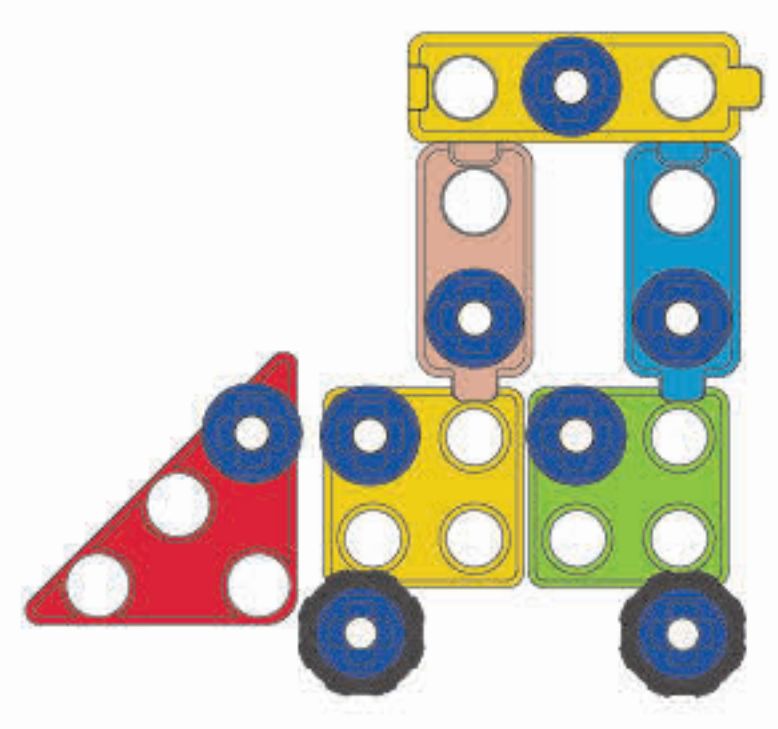
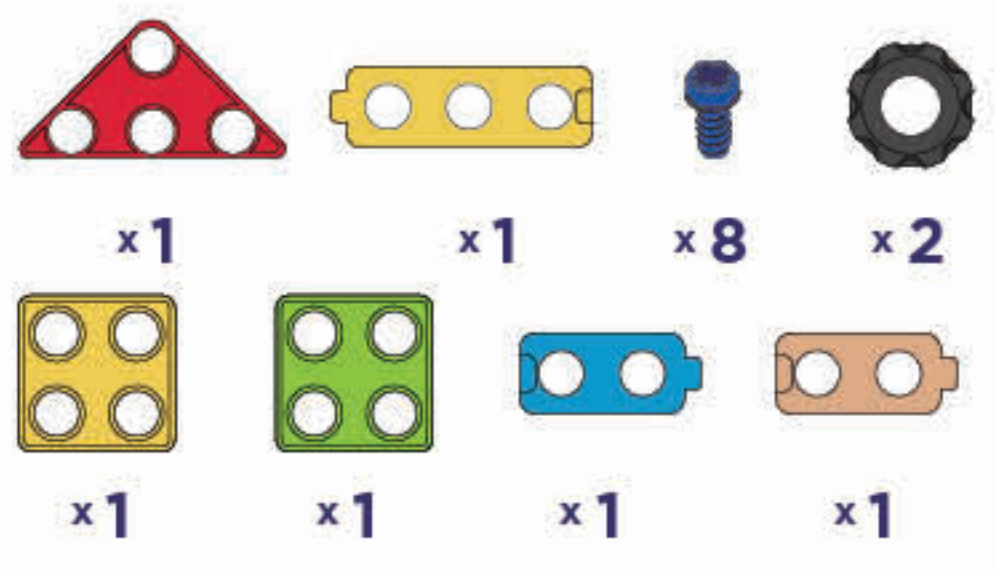

1

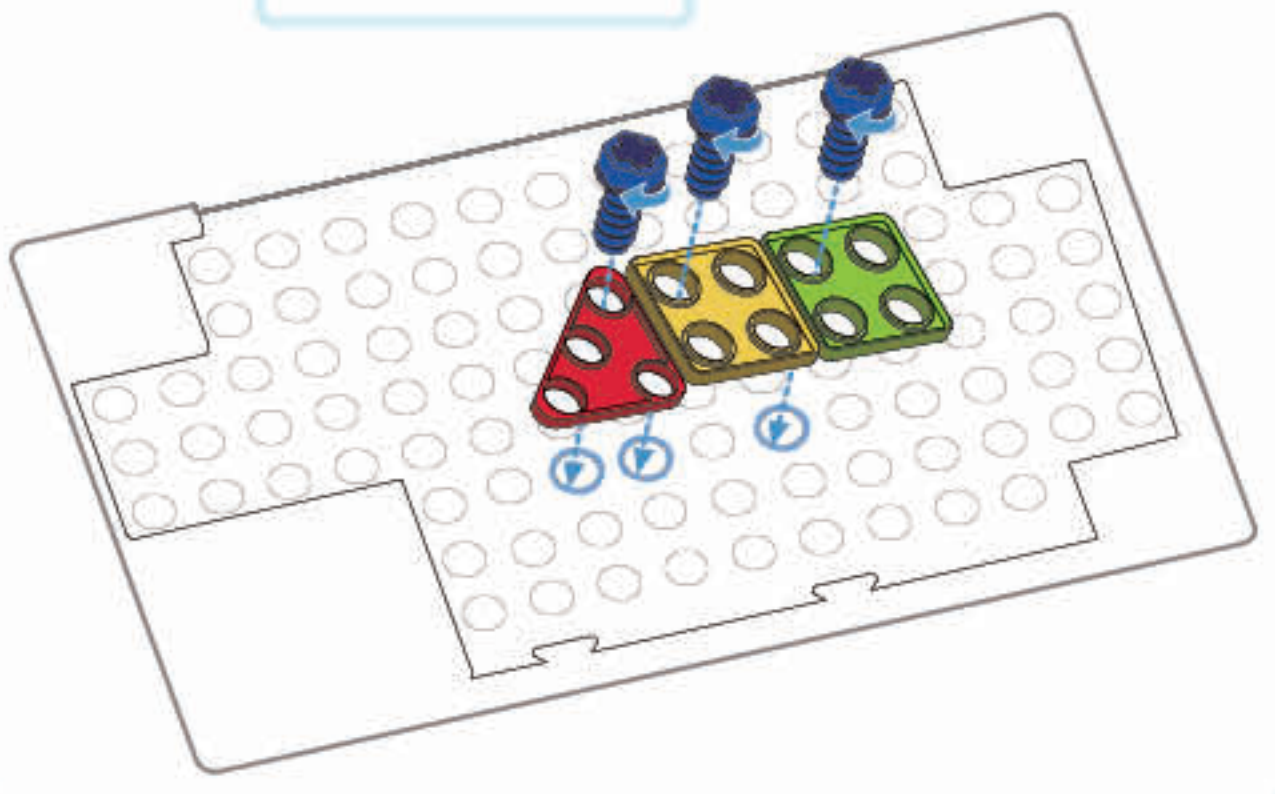
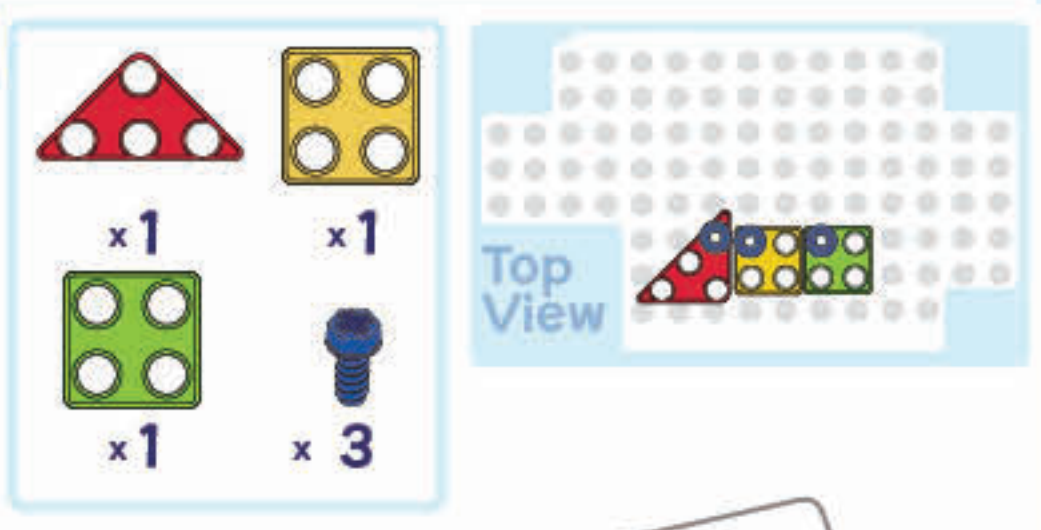

2

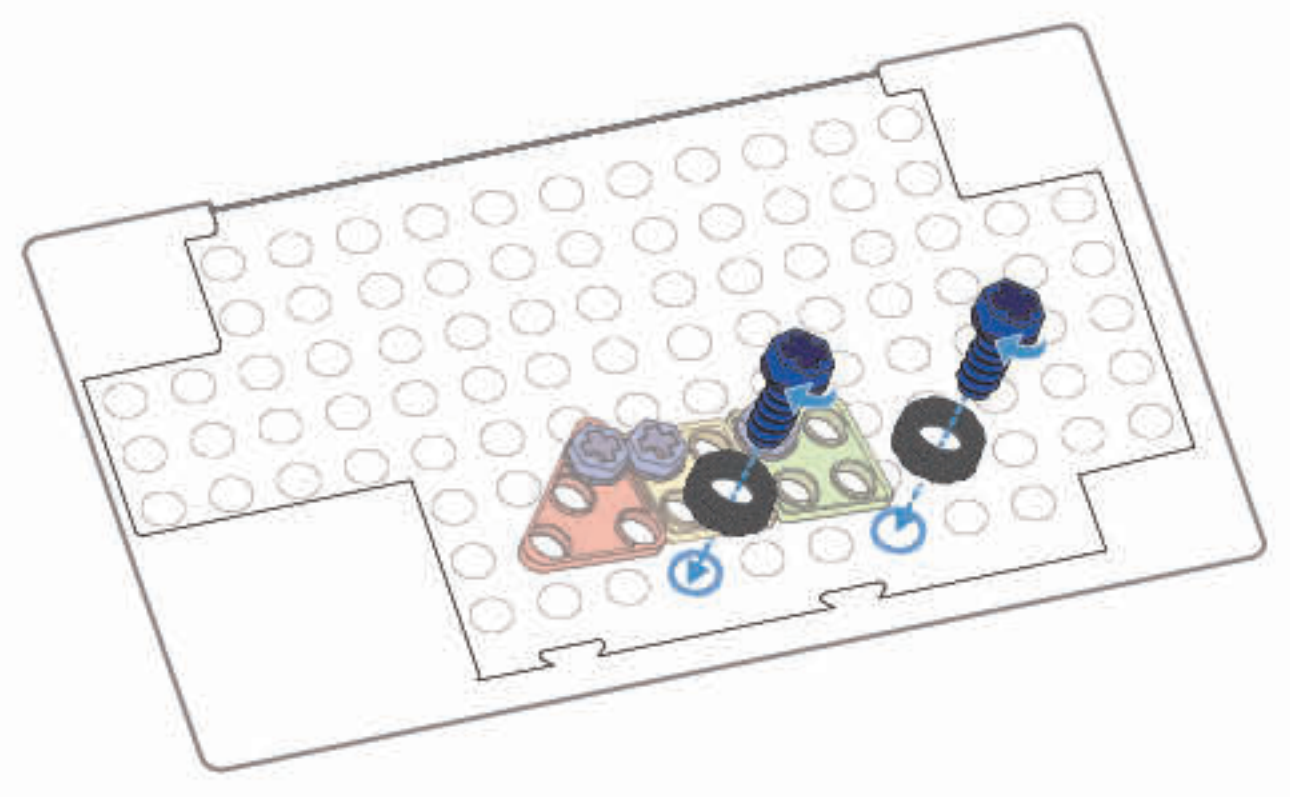
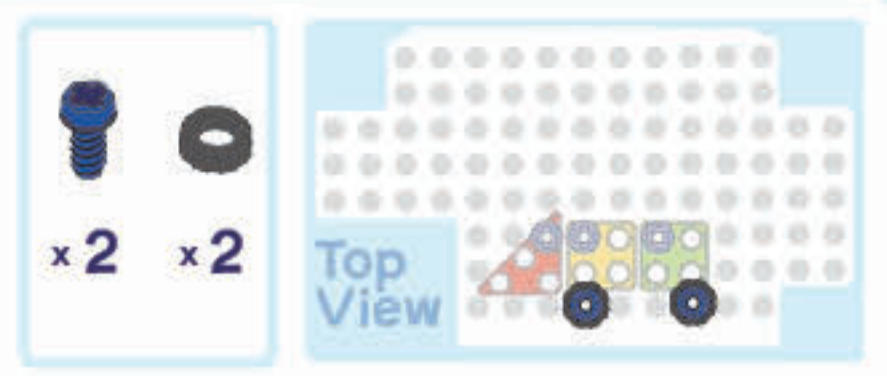

3

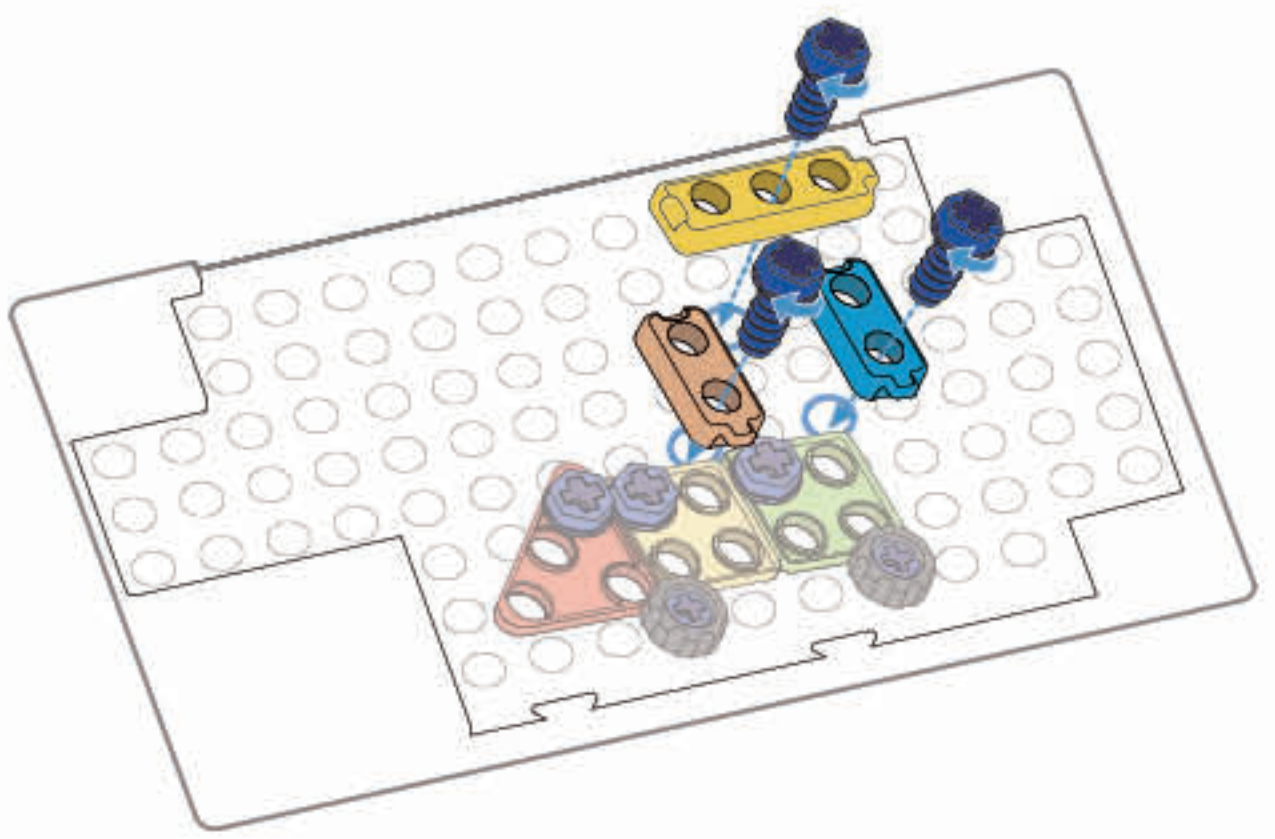
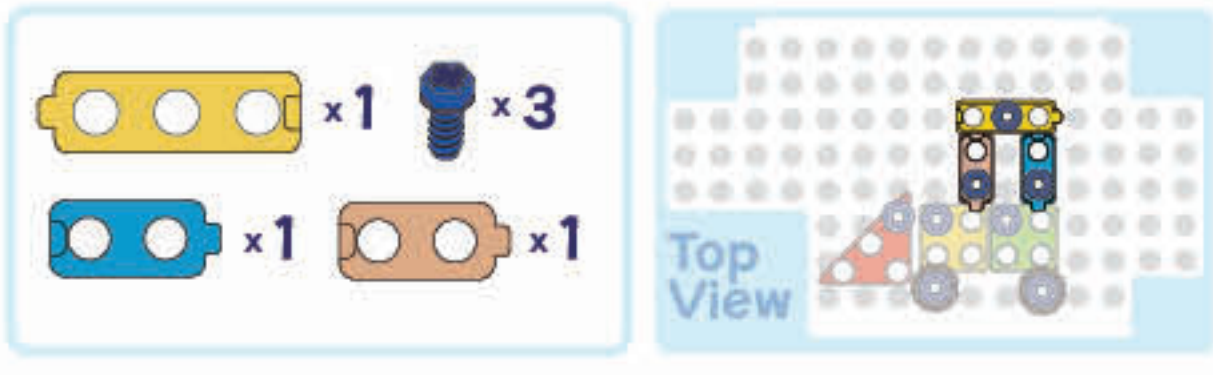

8



007

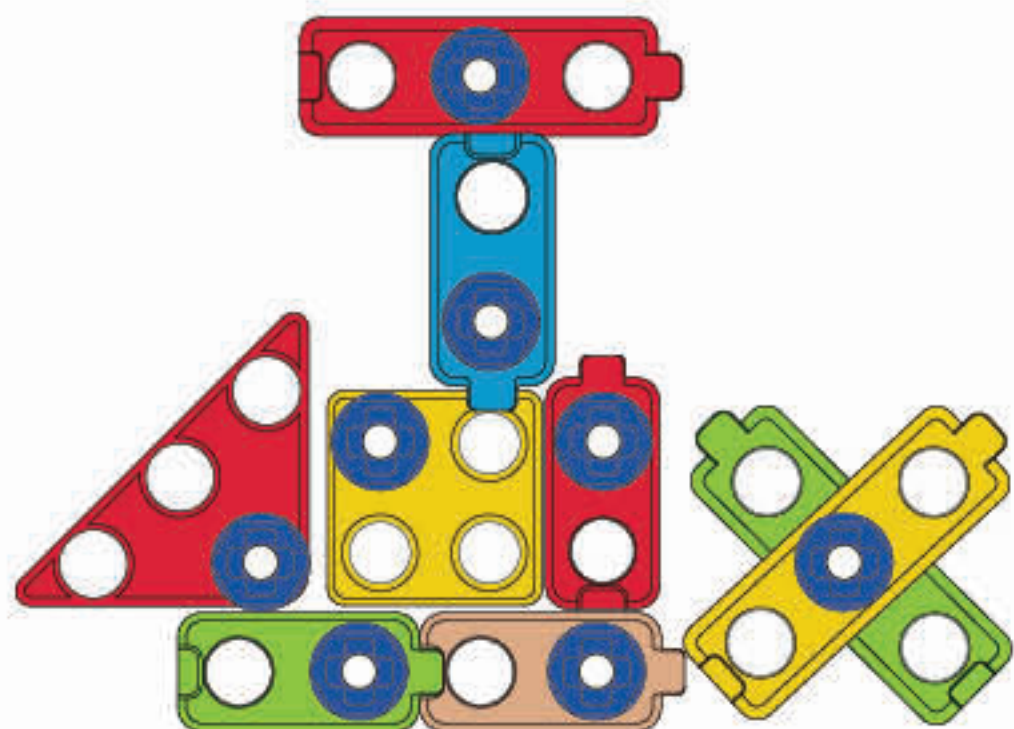
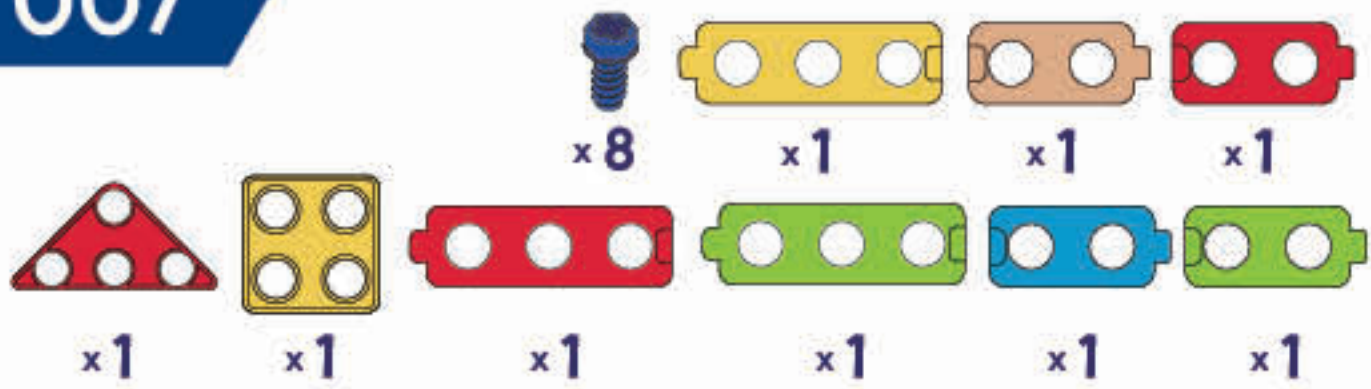

1

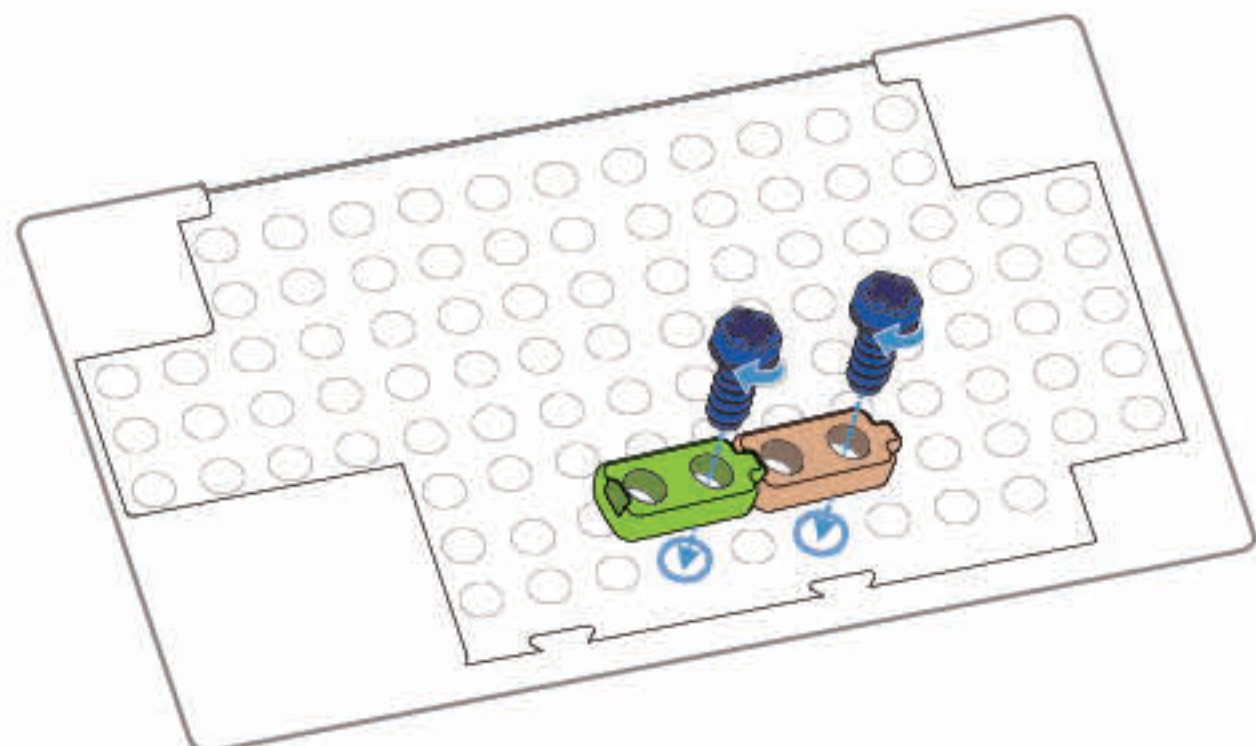
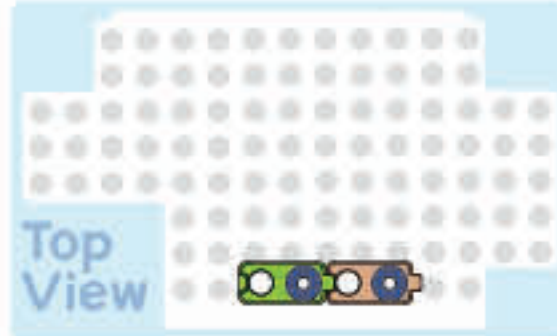
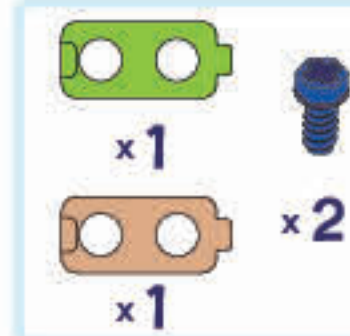

2

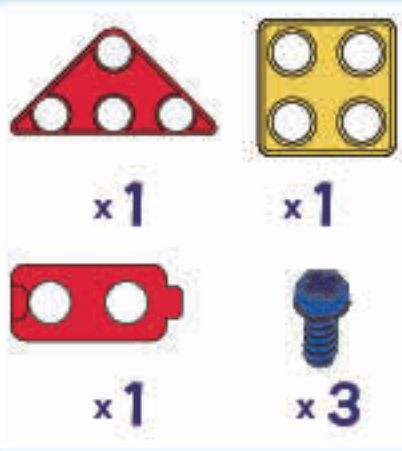

3

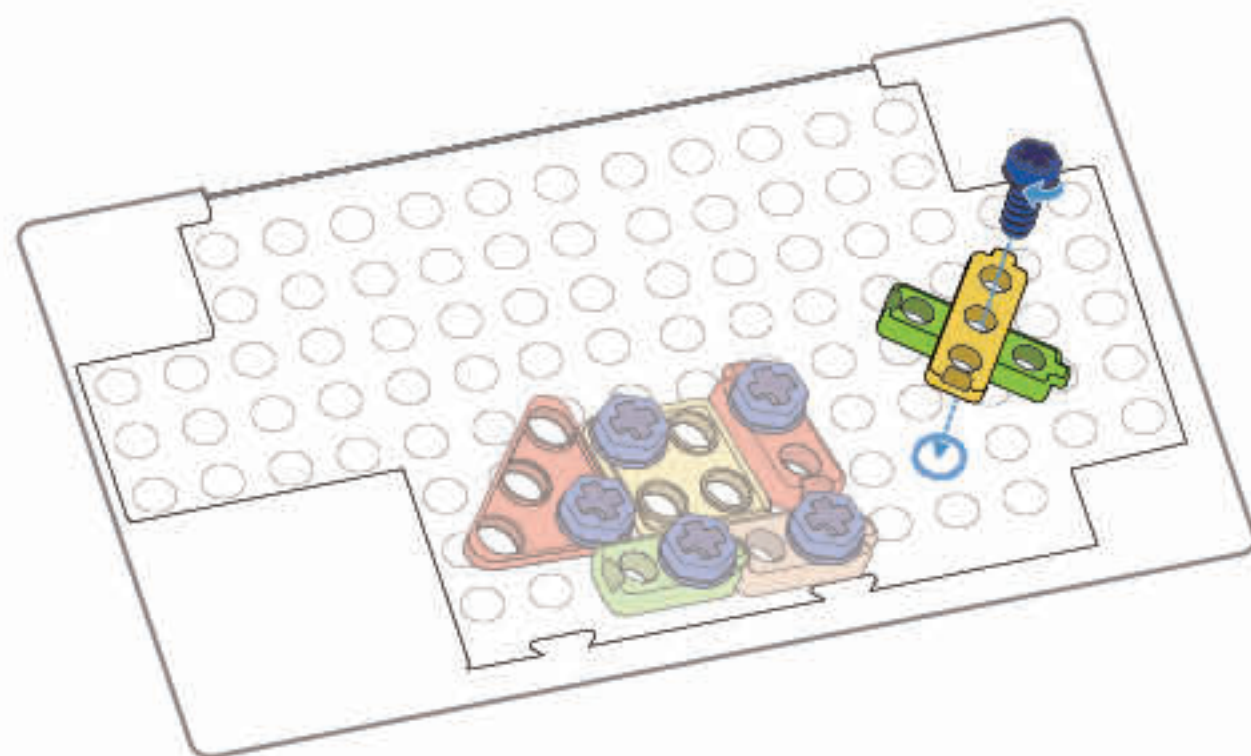
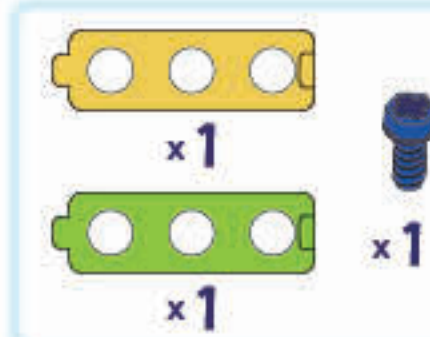

4

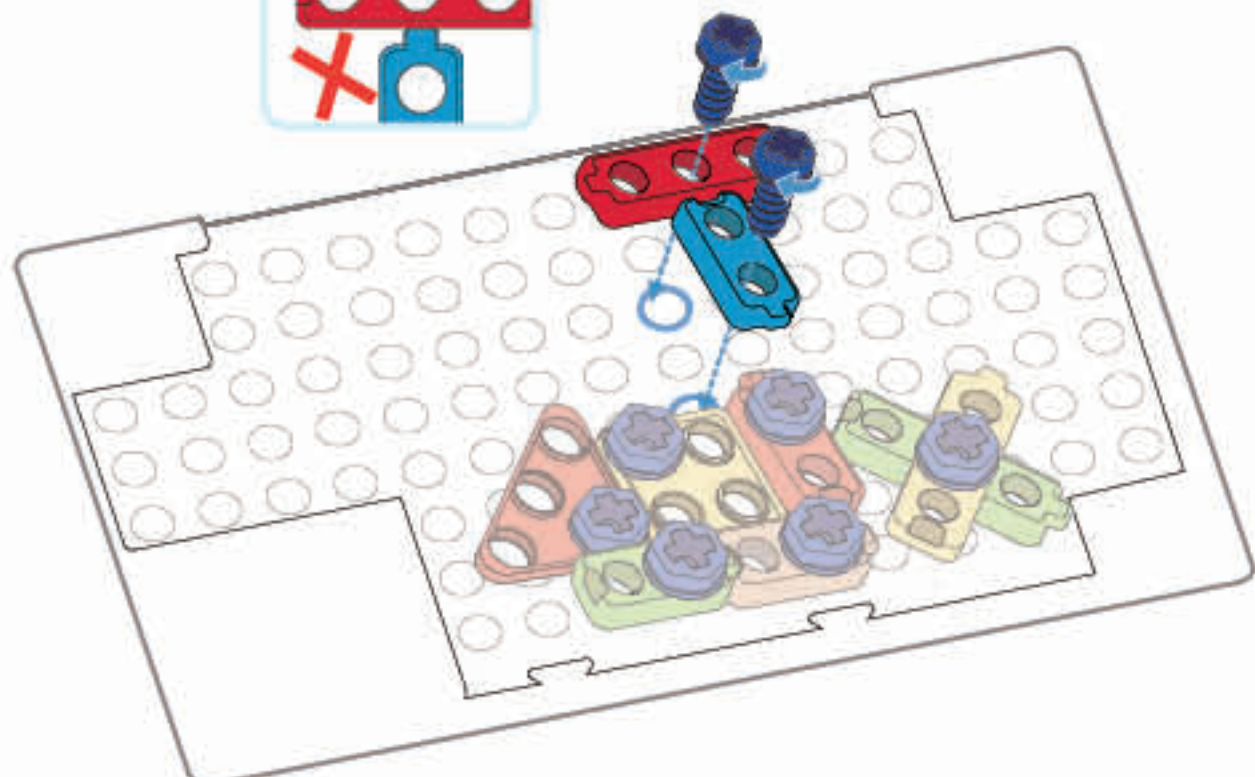
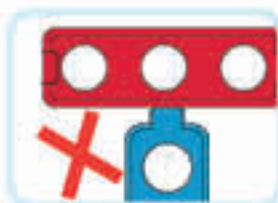
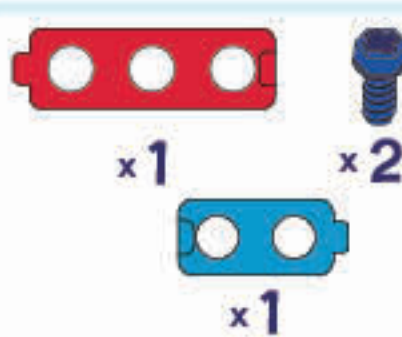







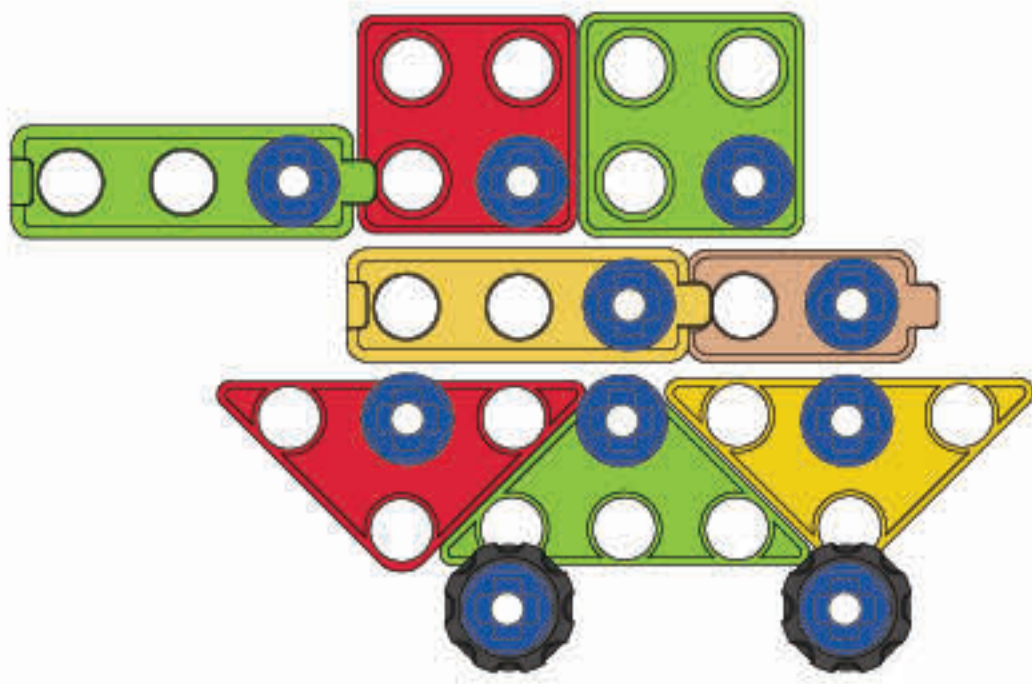



Well done!  
You made it!











-  x1
-  x1
-  x1
-  x1
-  x1
-  x1
-  x1
-  x1
-  x10
-  x2

1

-  x1
-  x1
-  x1
-  x3

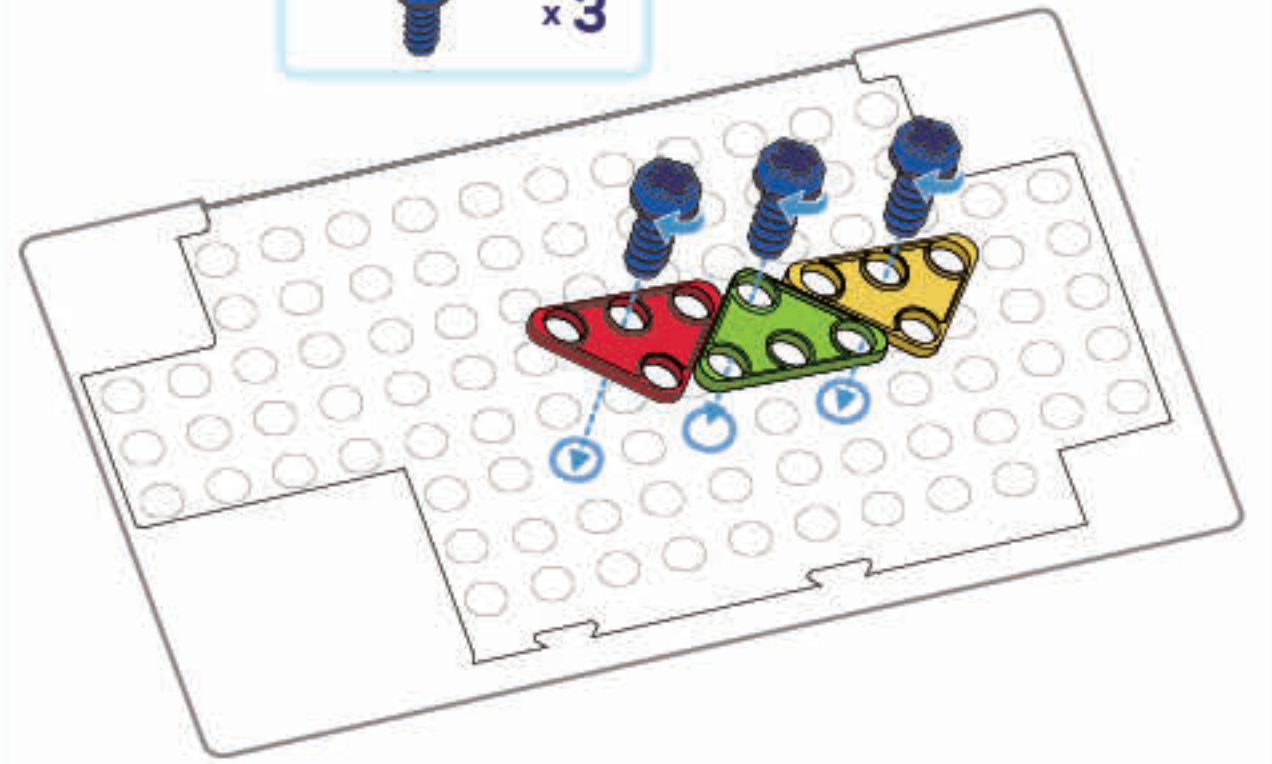

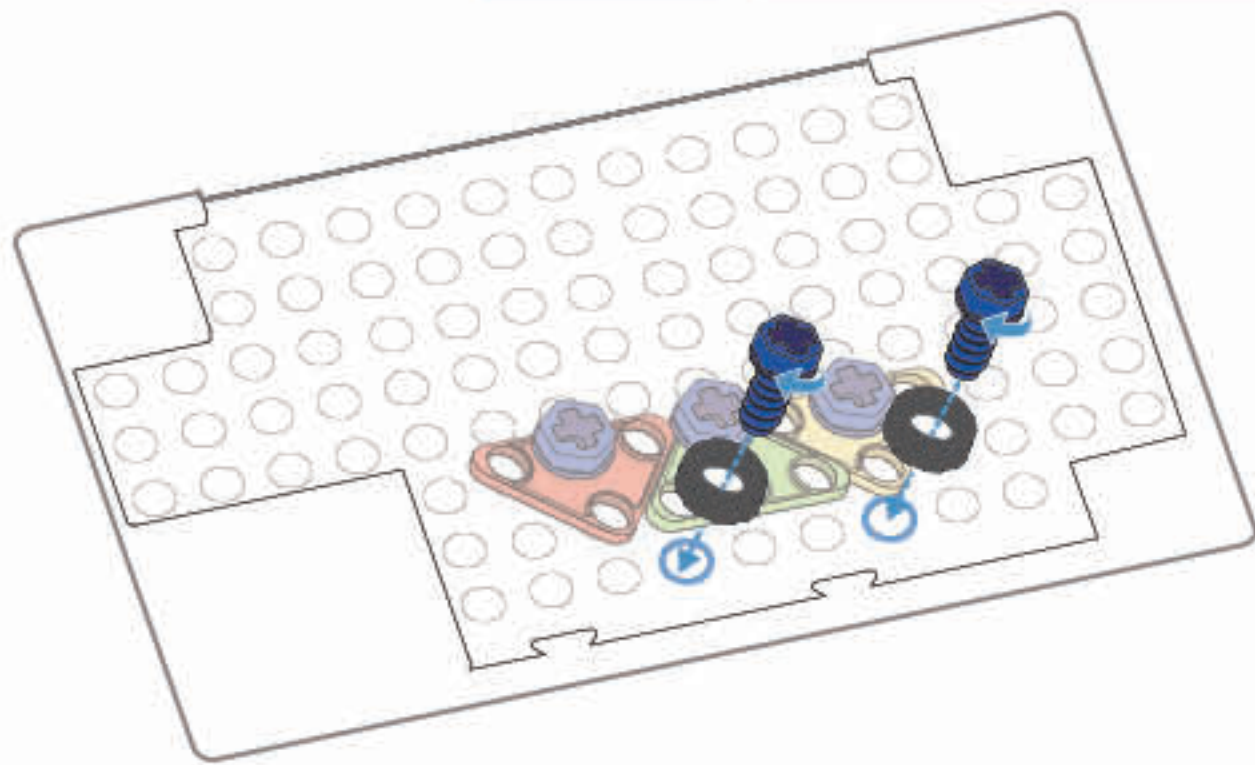
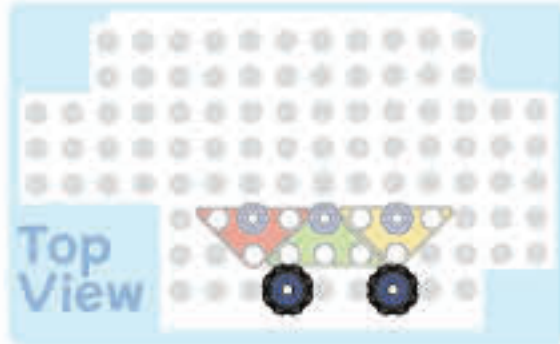

2

-  x2
-  x2





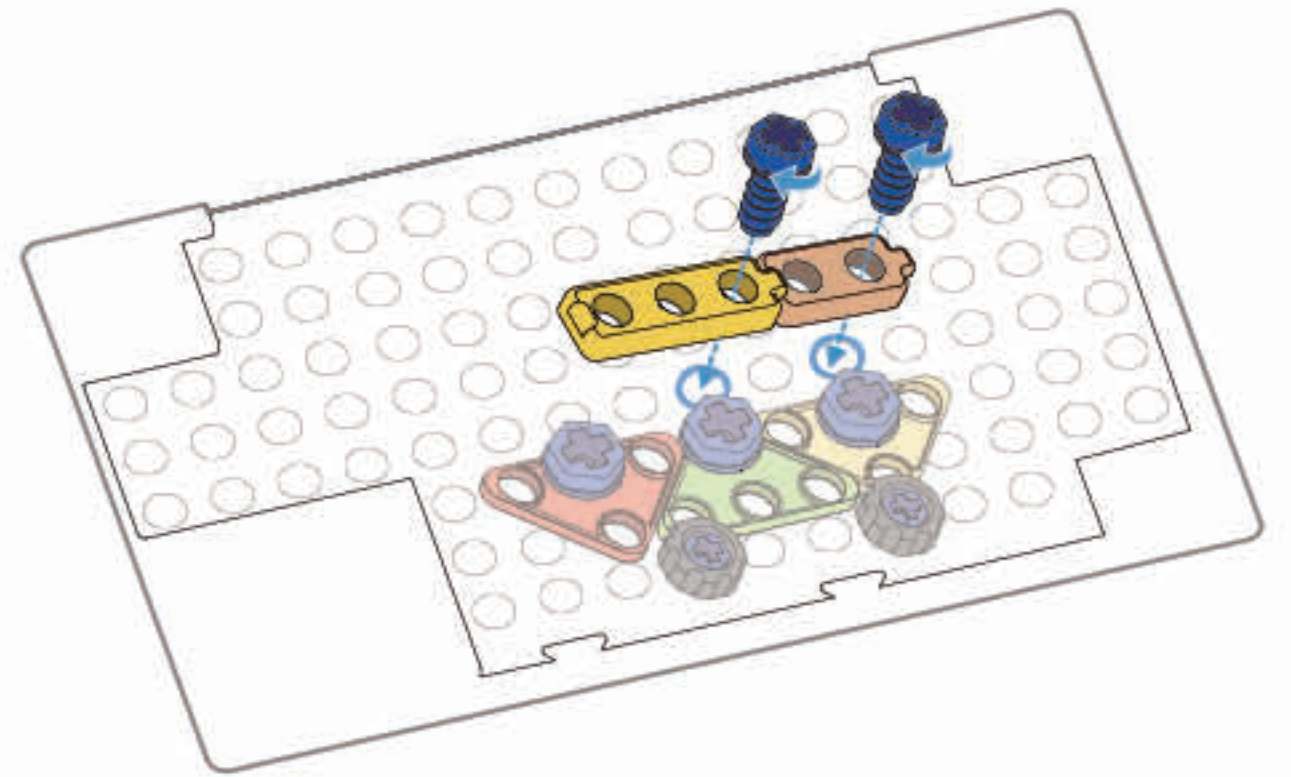
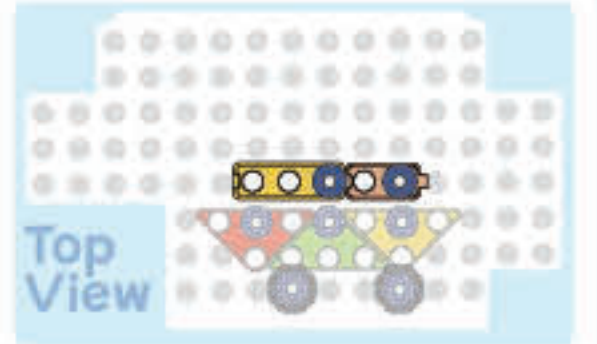

3

-  x1
-  x1
-  x2



4

-  x1
-  x3
-  x1
-  x1

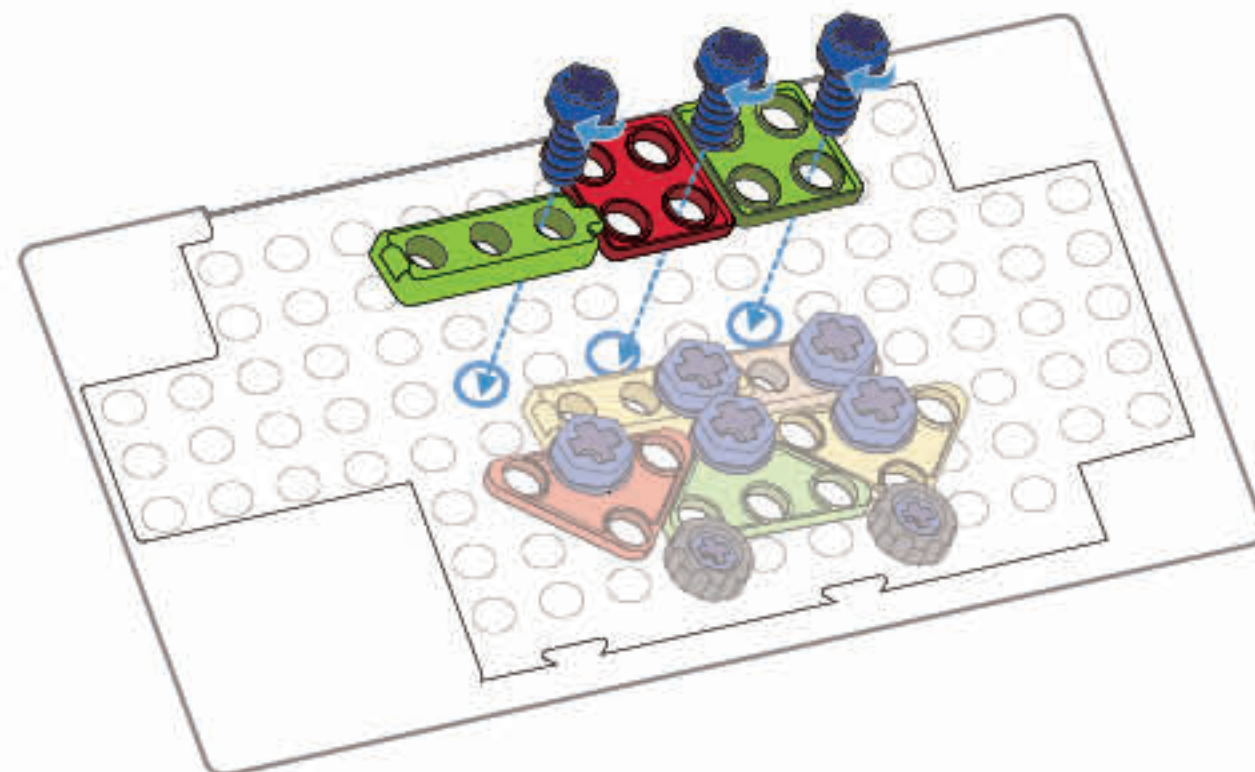
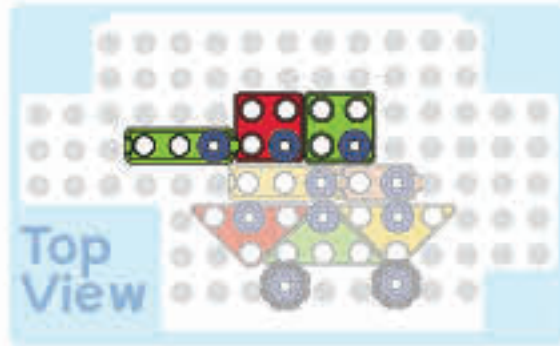

Well done!  
You made it!





009

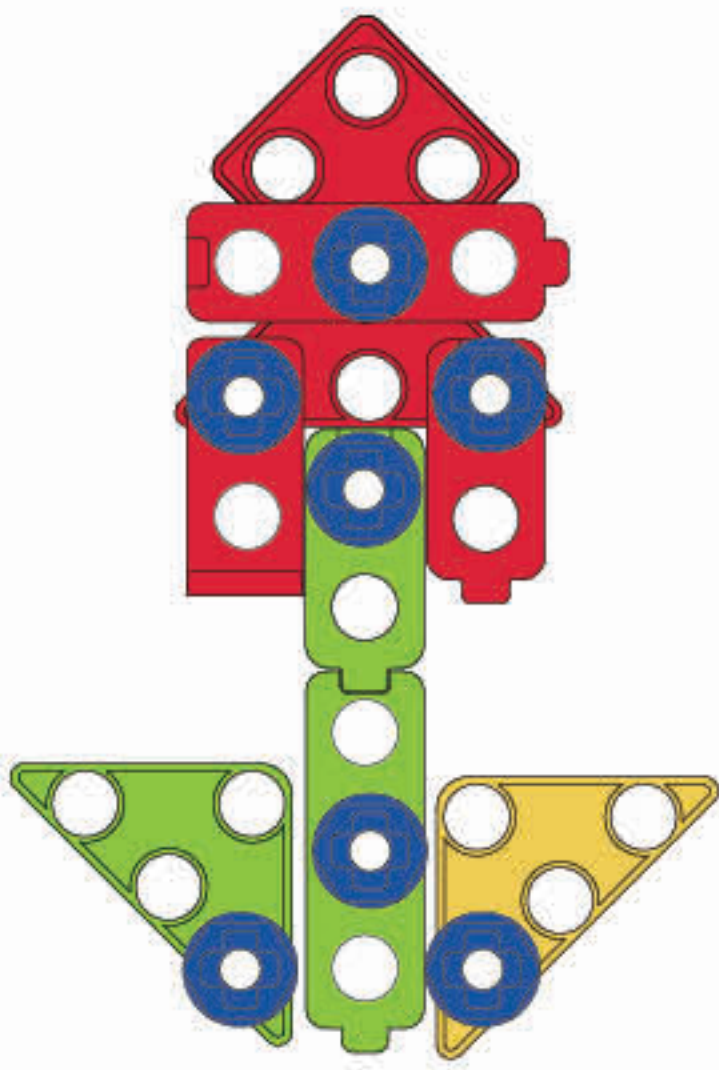
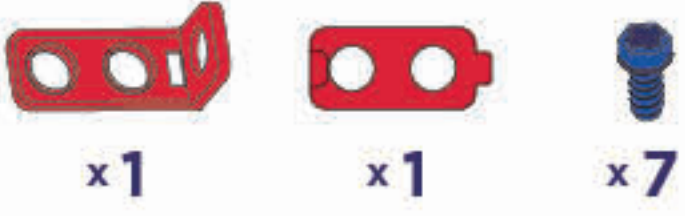
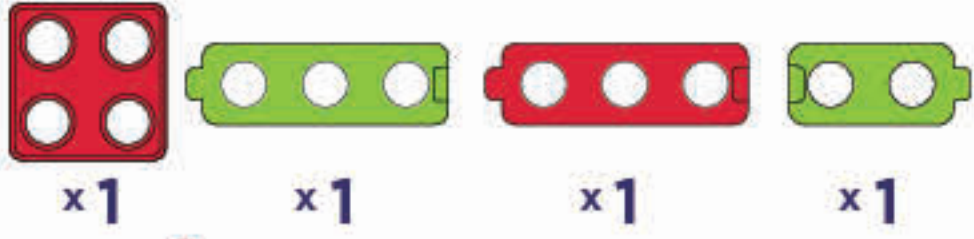
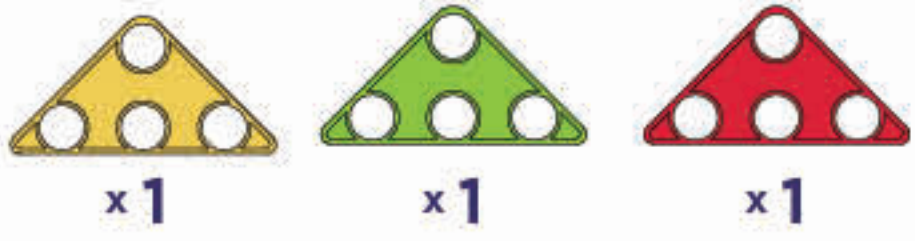

1

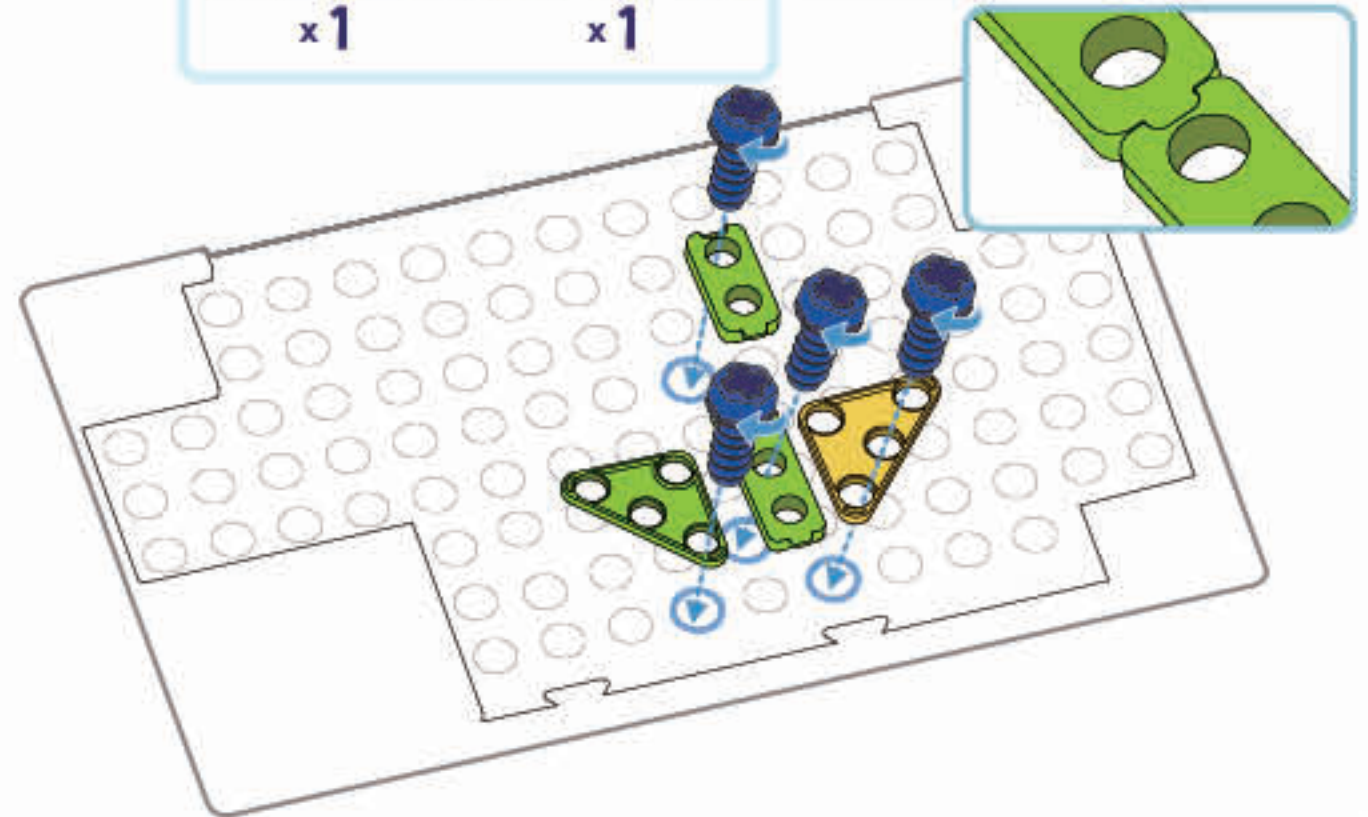
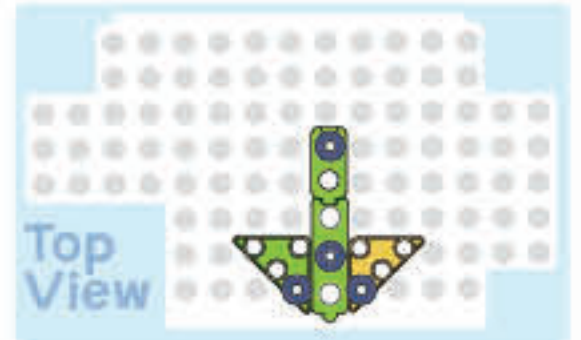
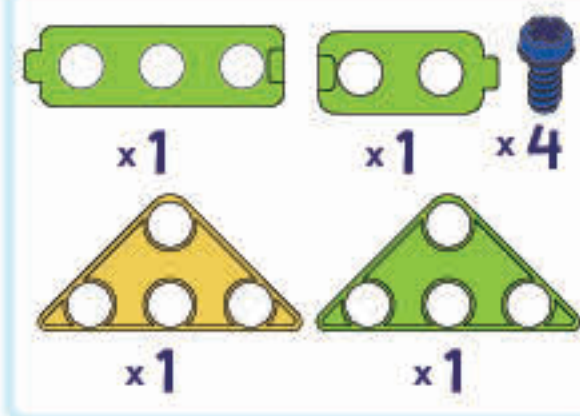

2

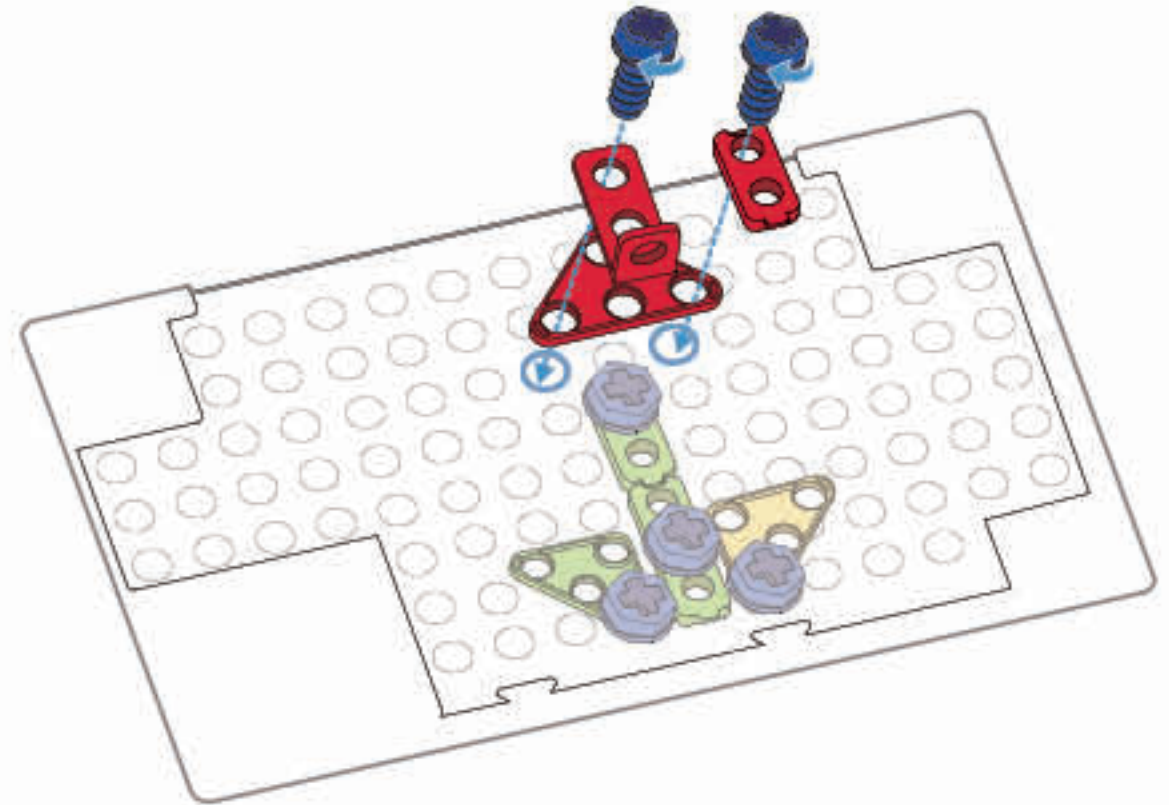
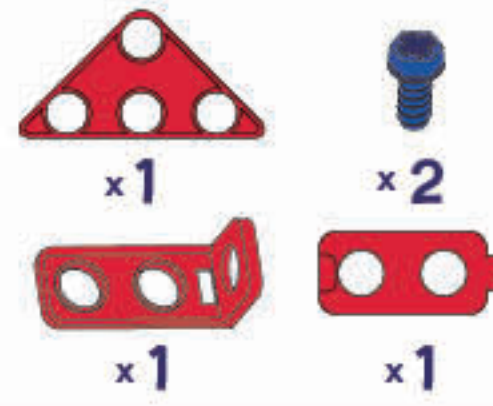

3

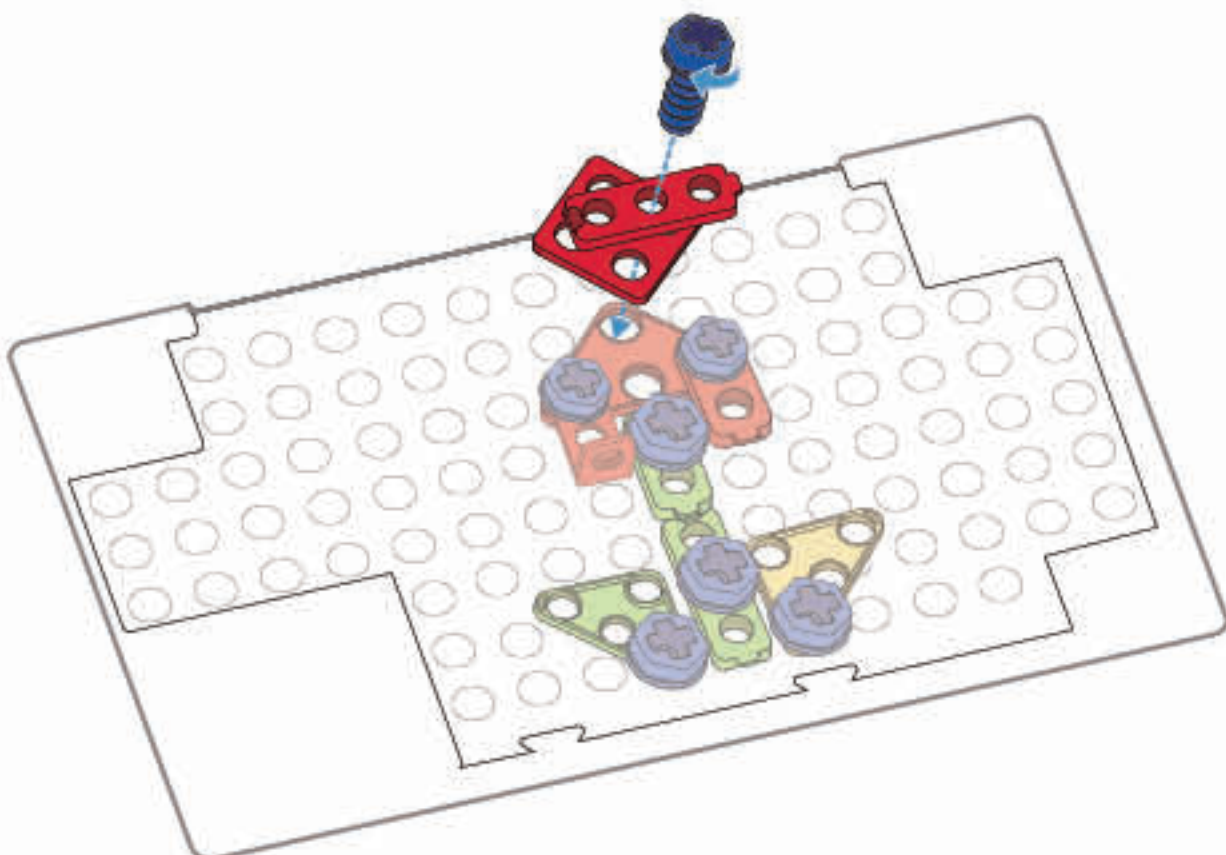
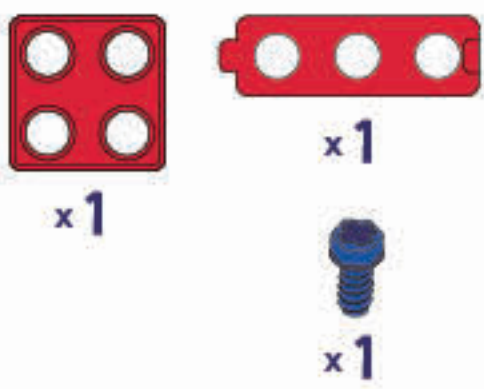

Well done!  
You made it!





010

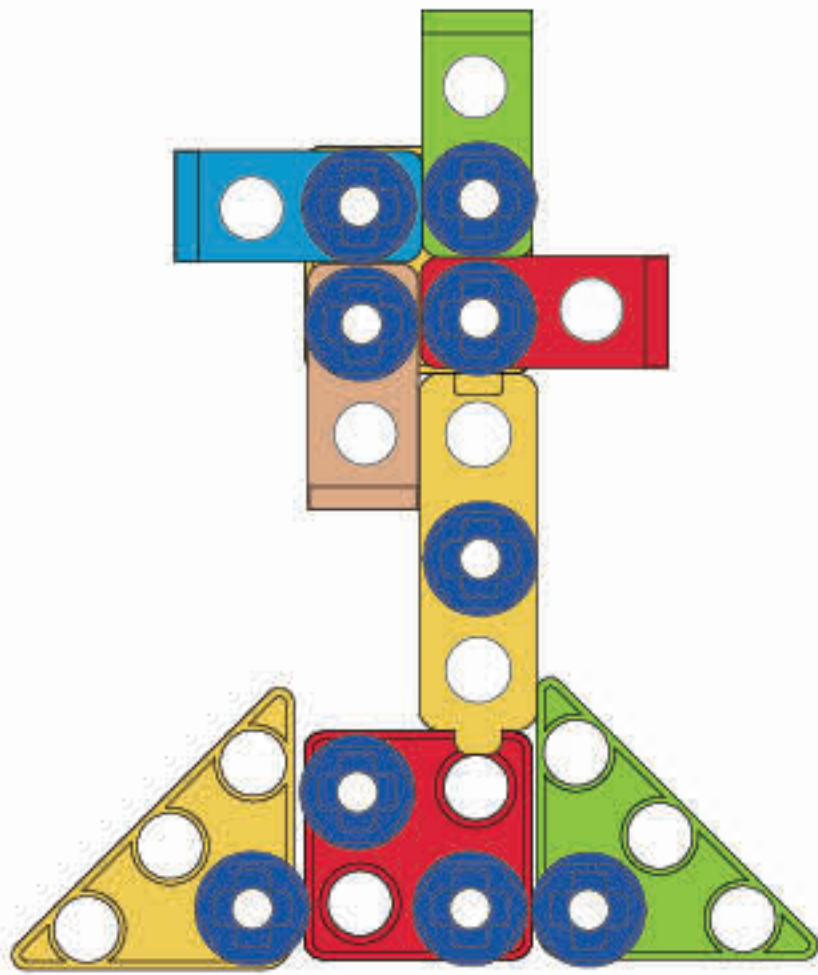
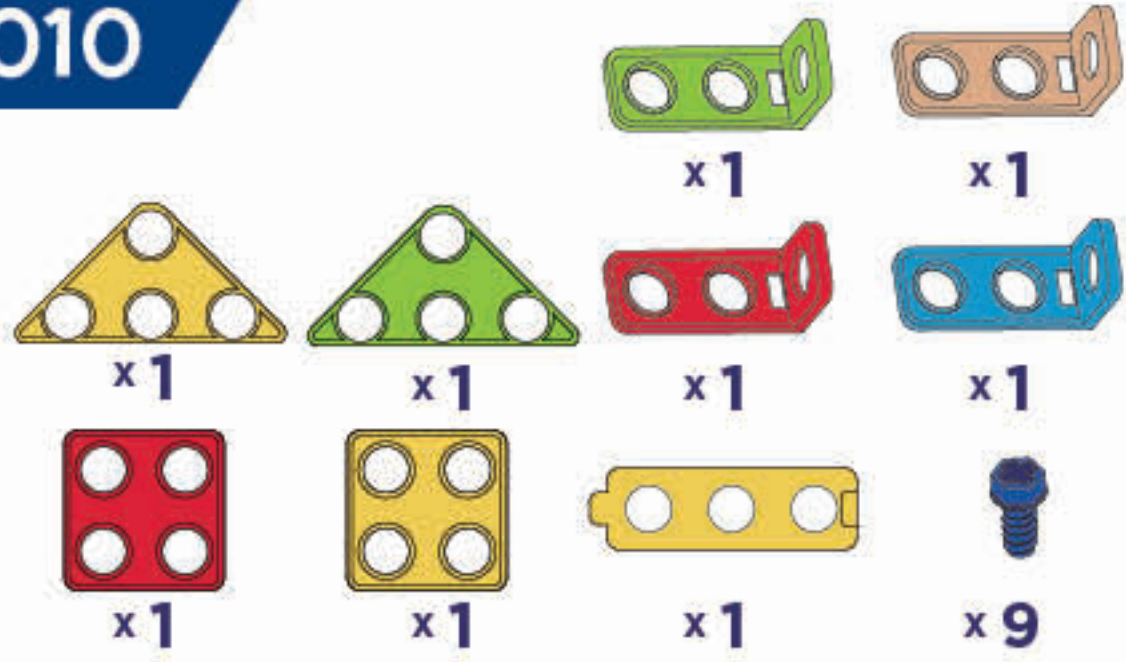

1

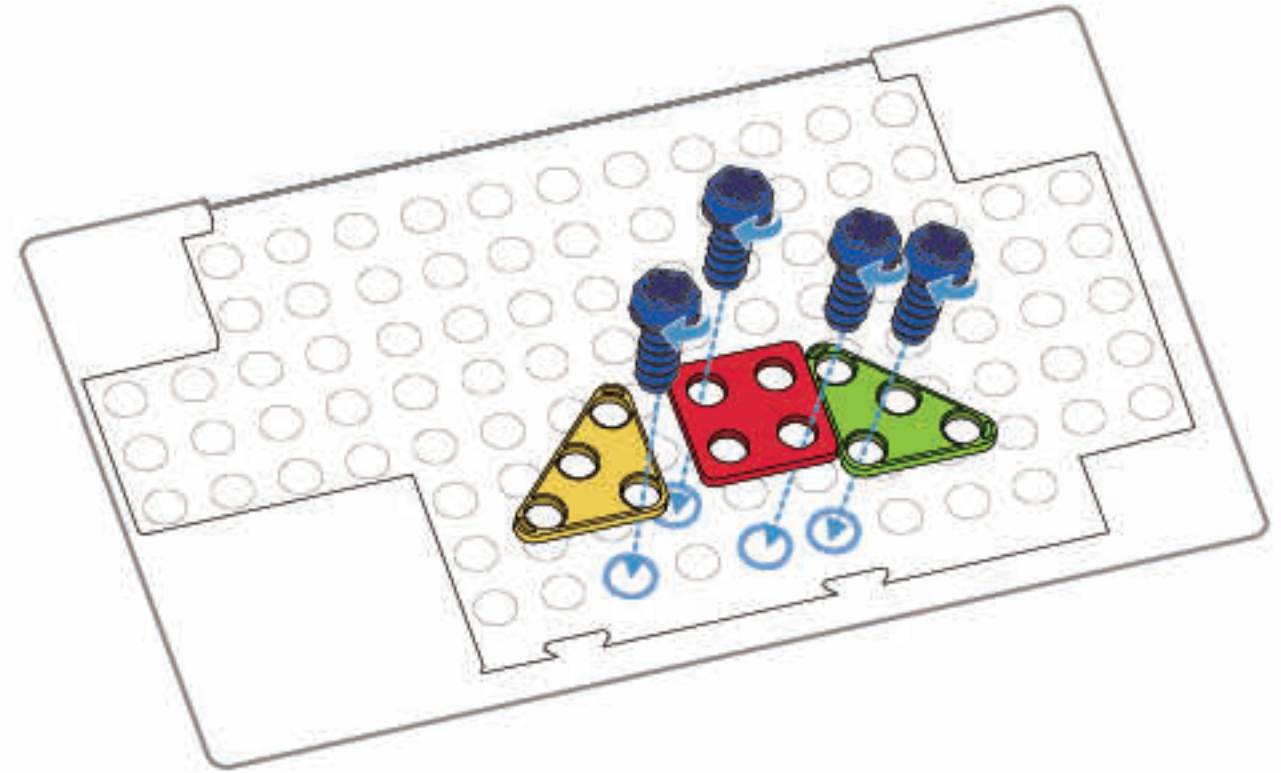
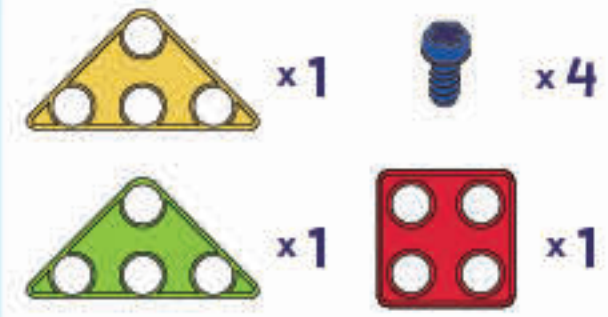

2

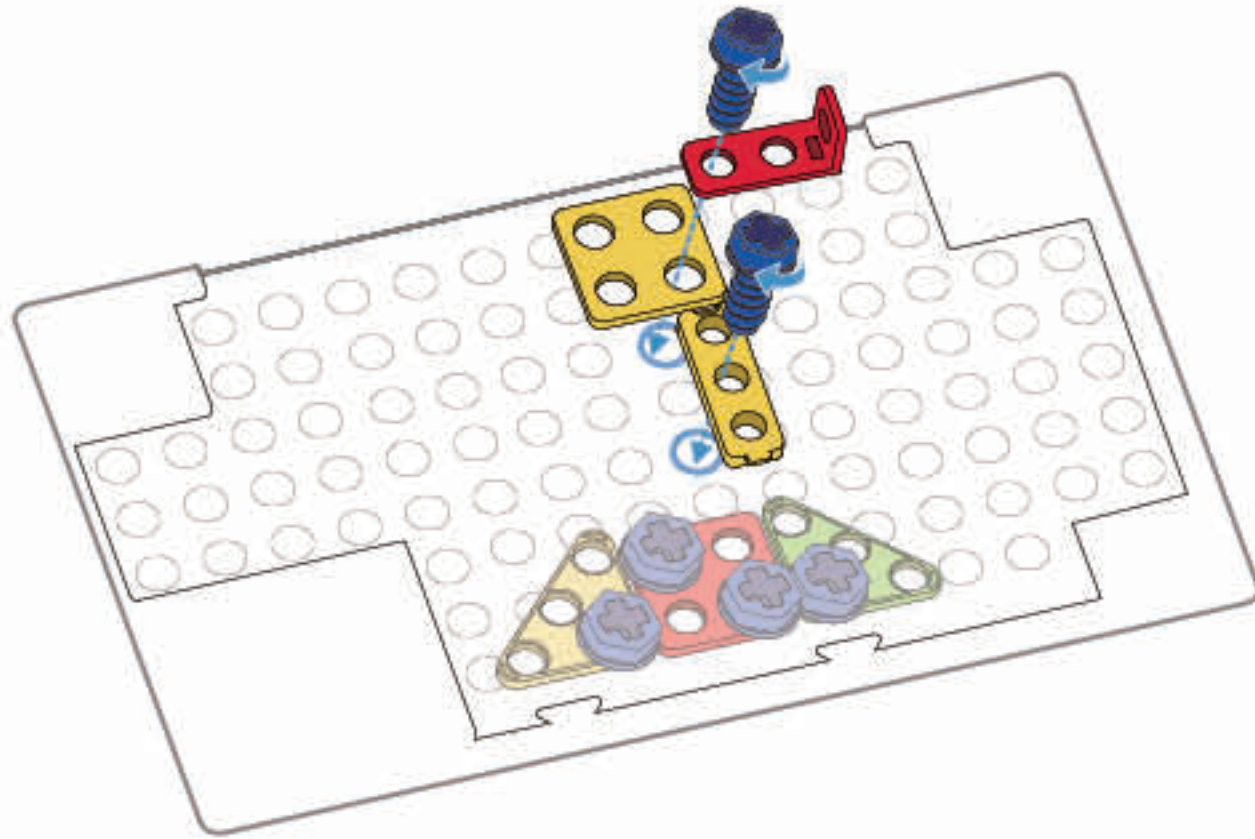
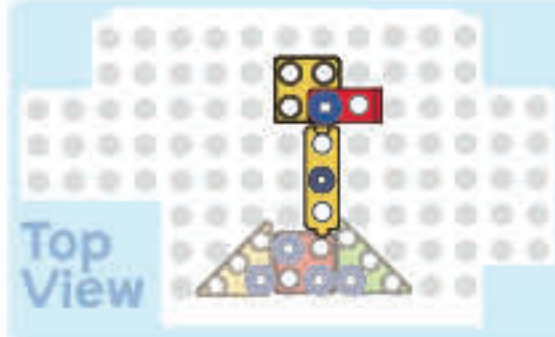
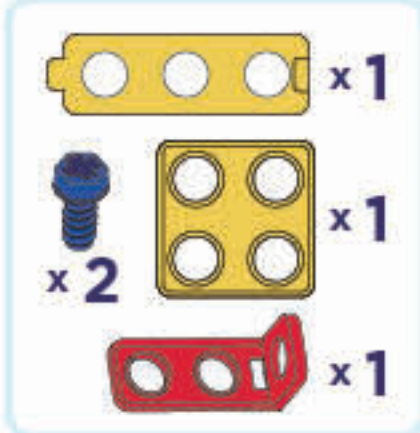

3

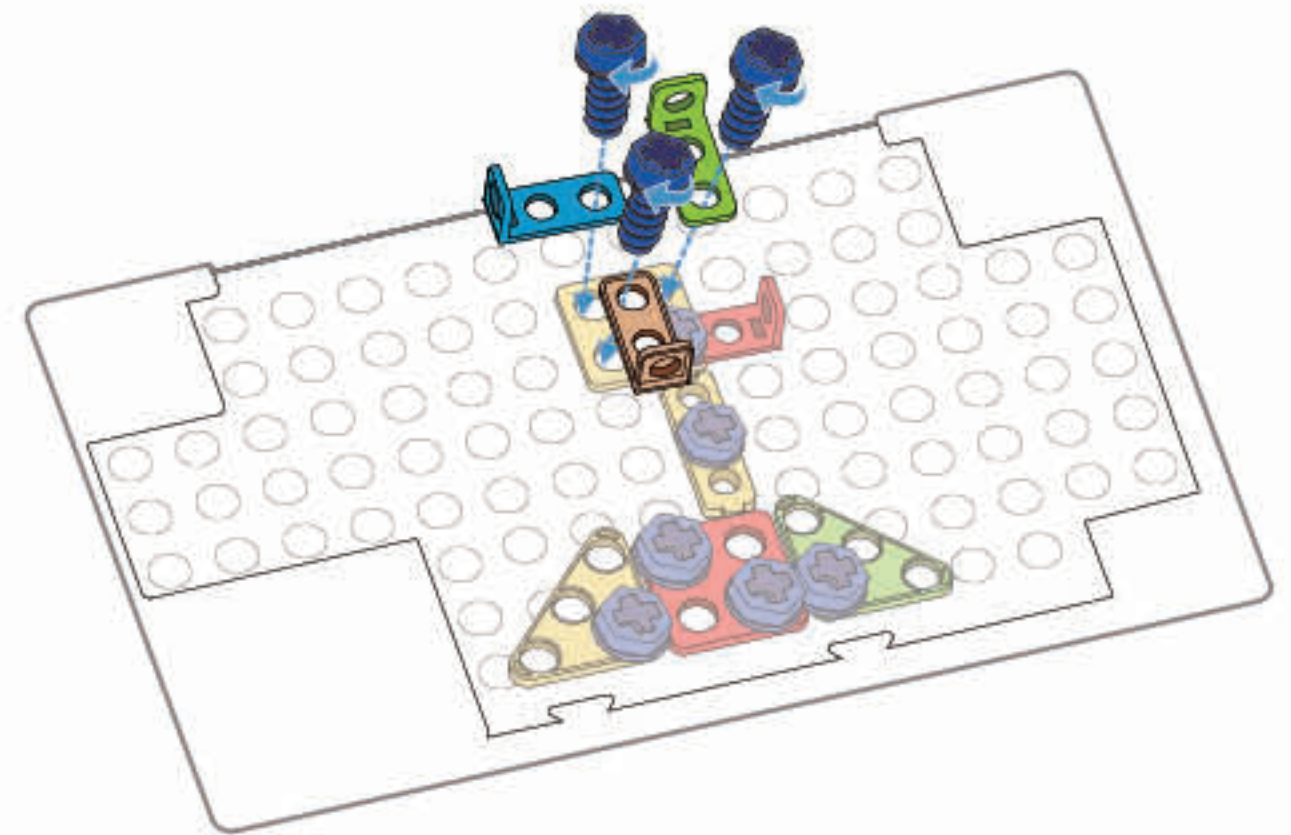

Well done!  
You made it!





# Level 3

011

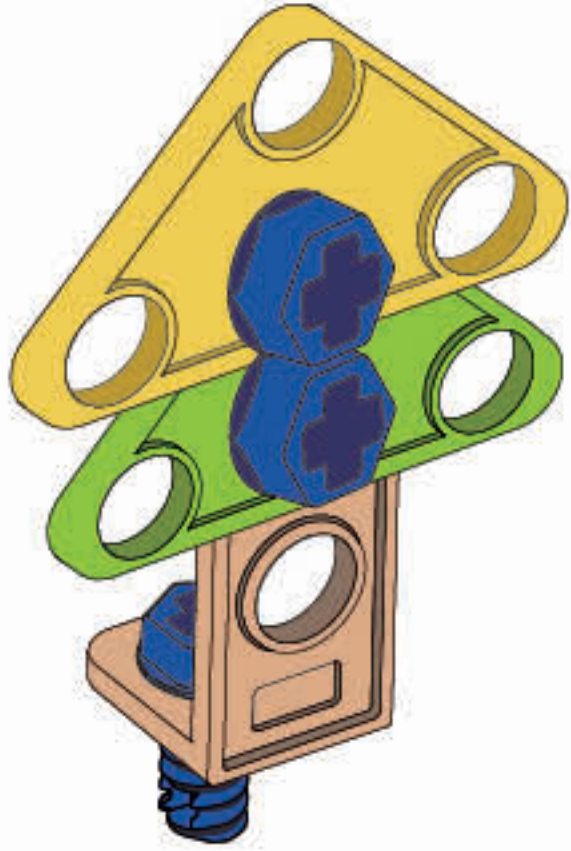
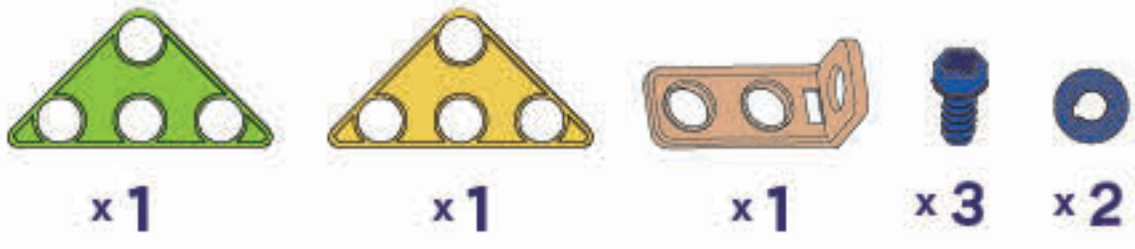

1

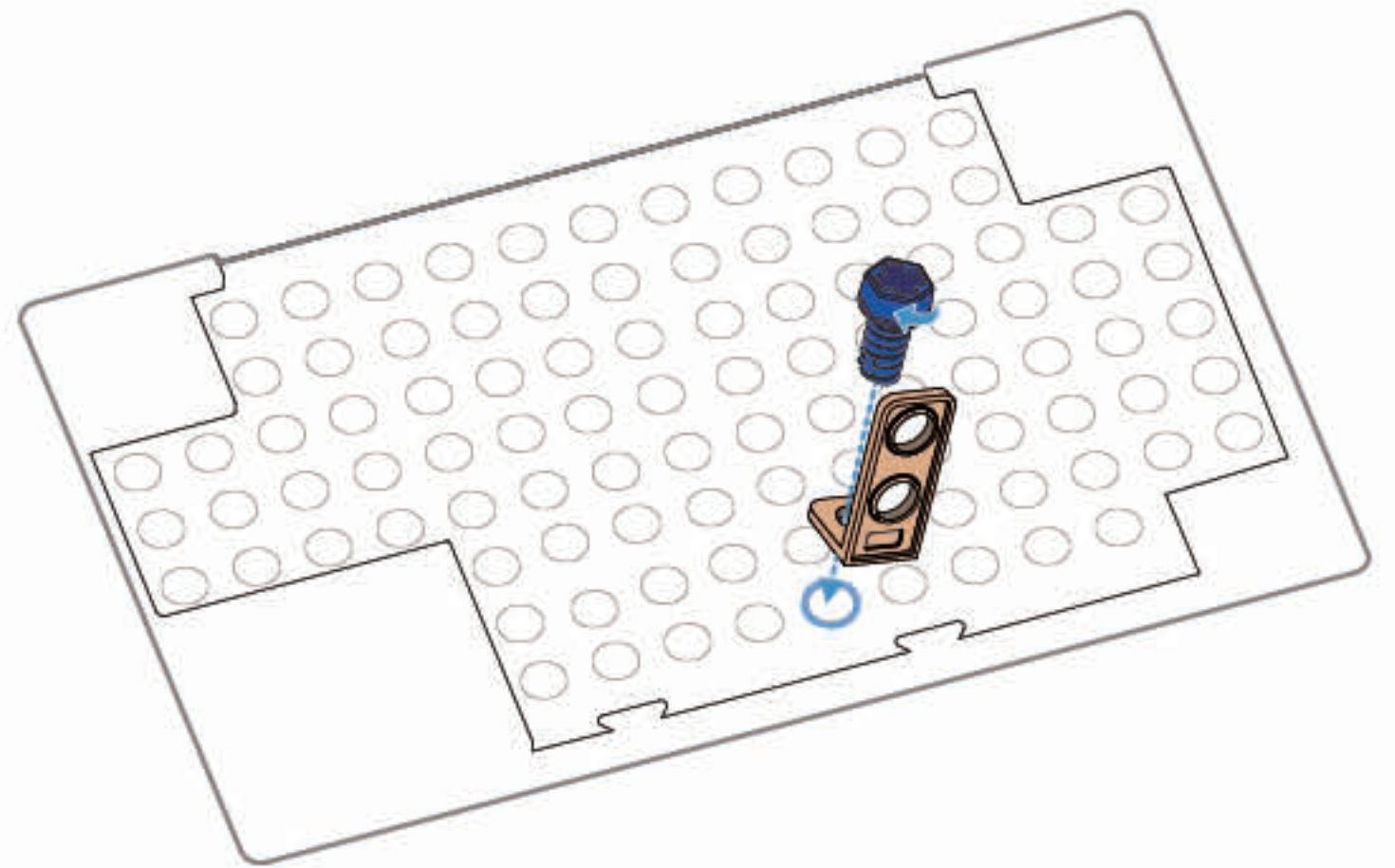

2

Back

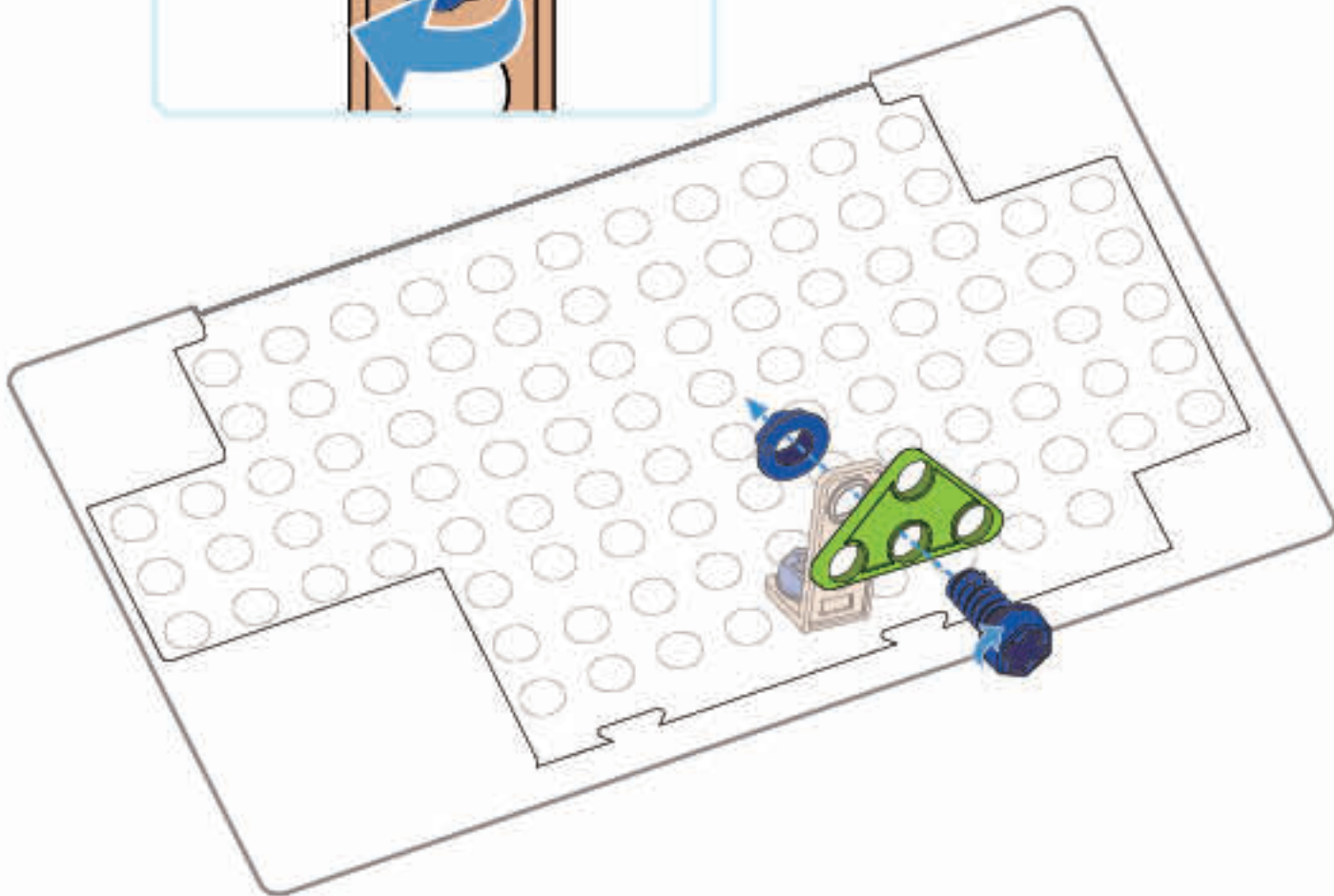
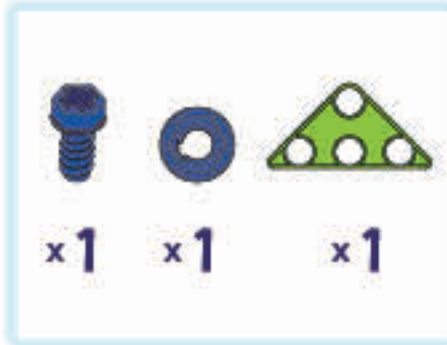
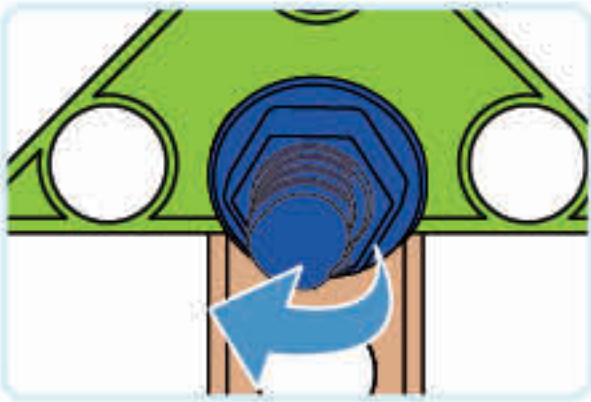

3

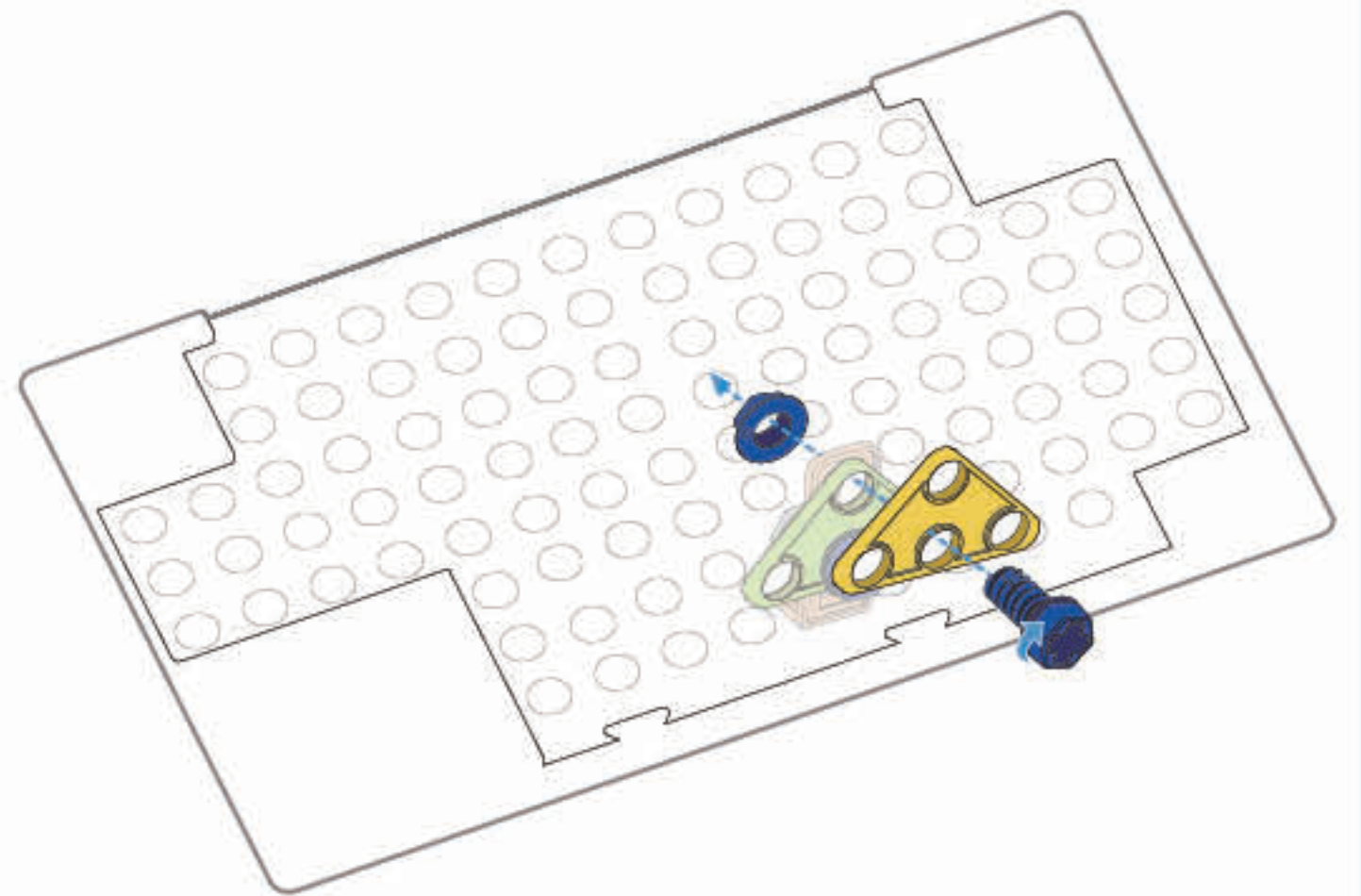
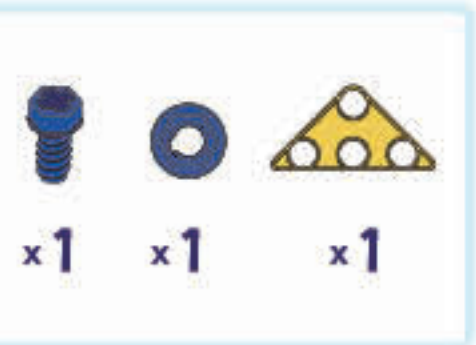

Well done!  
You made it!





012

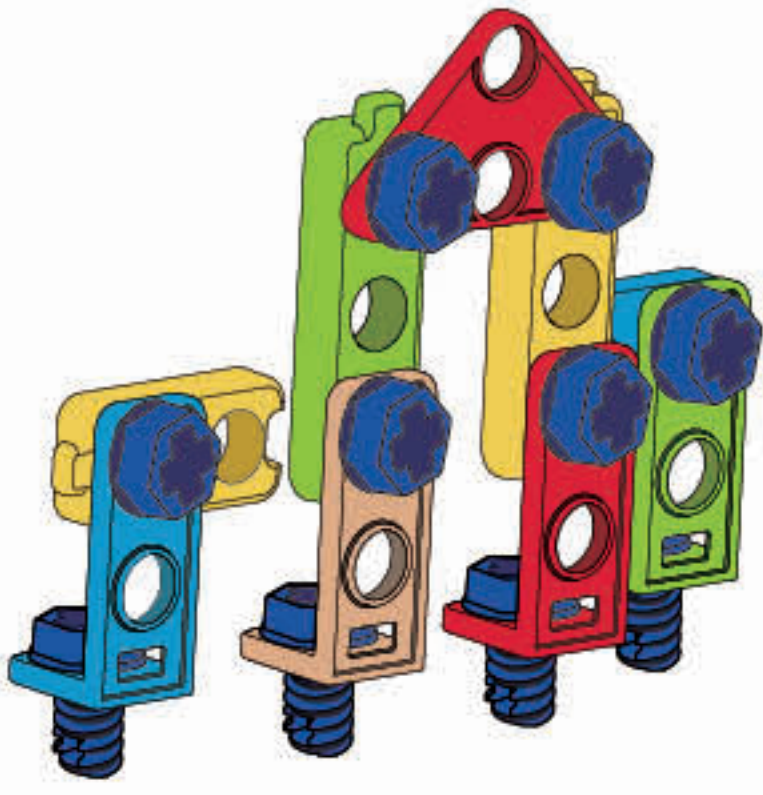
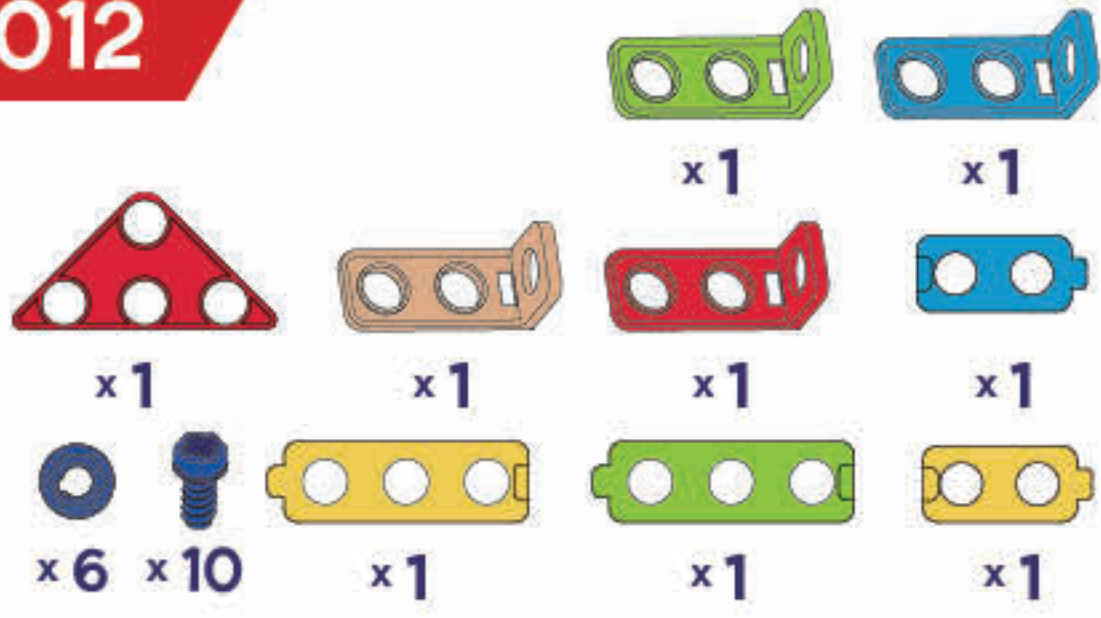

1

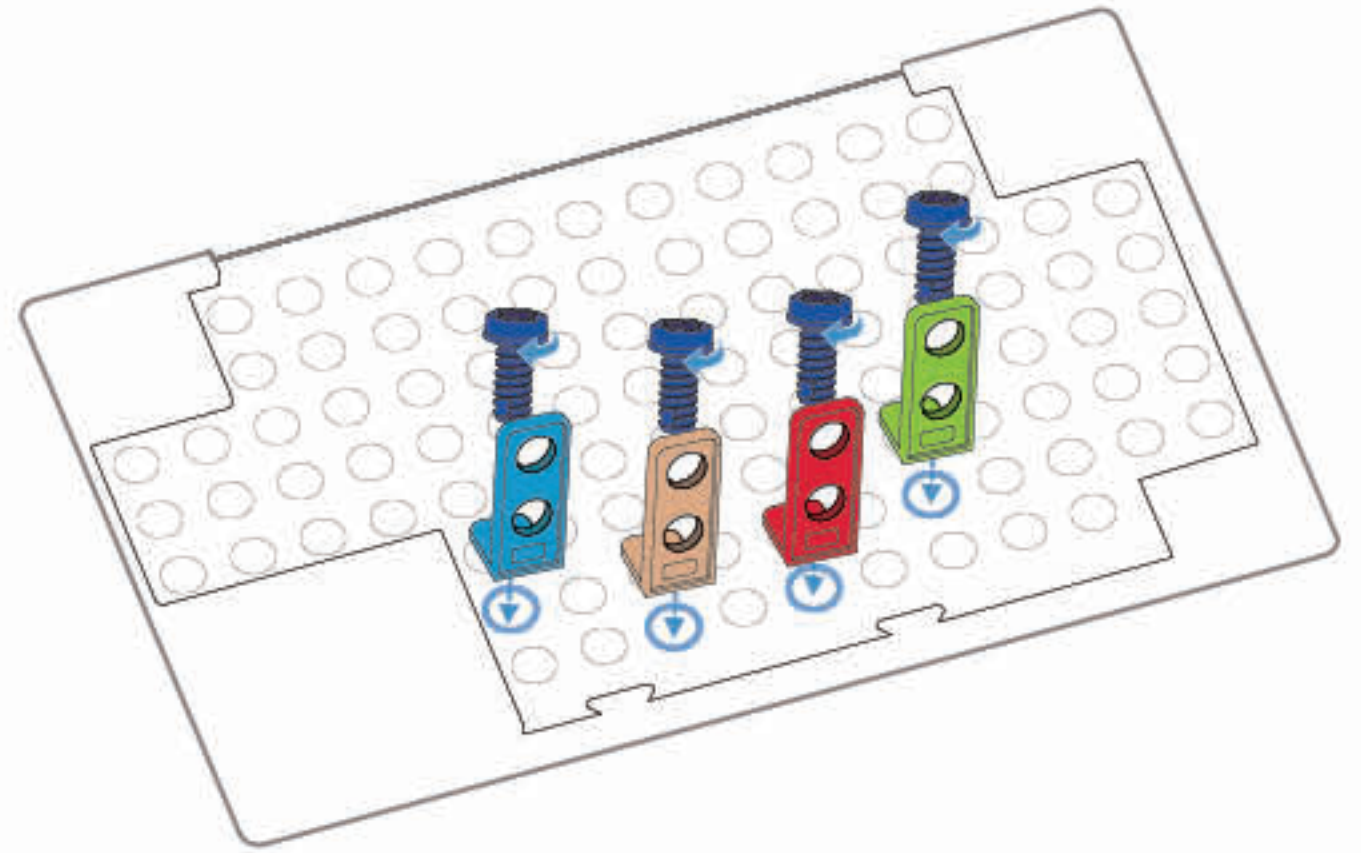
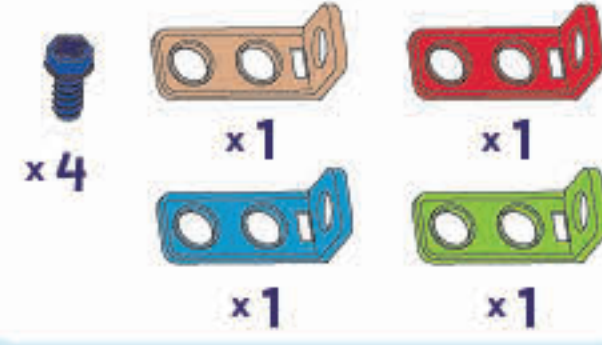

2

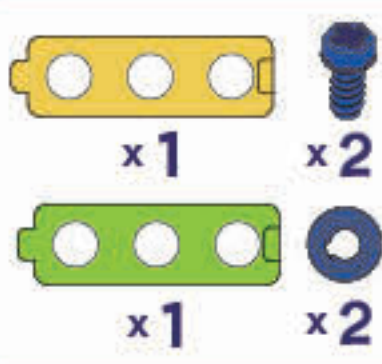

Back

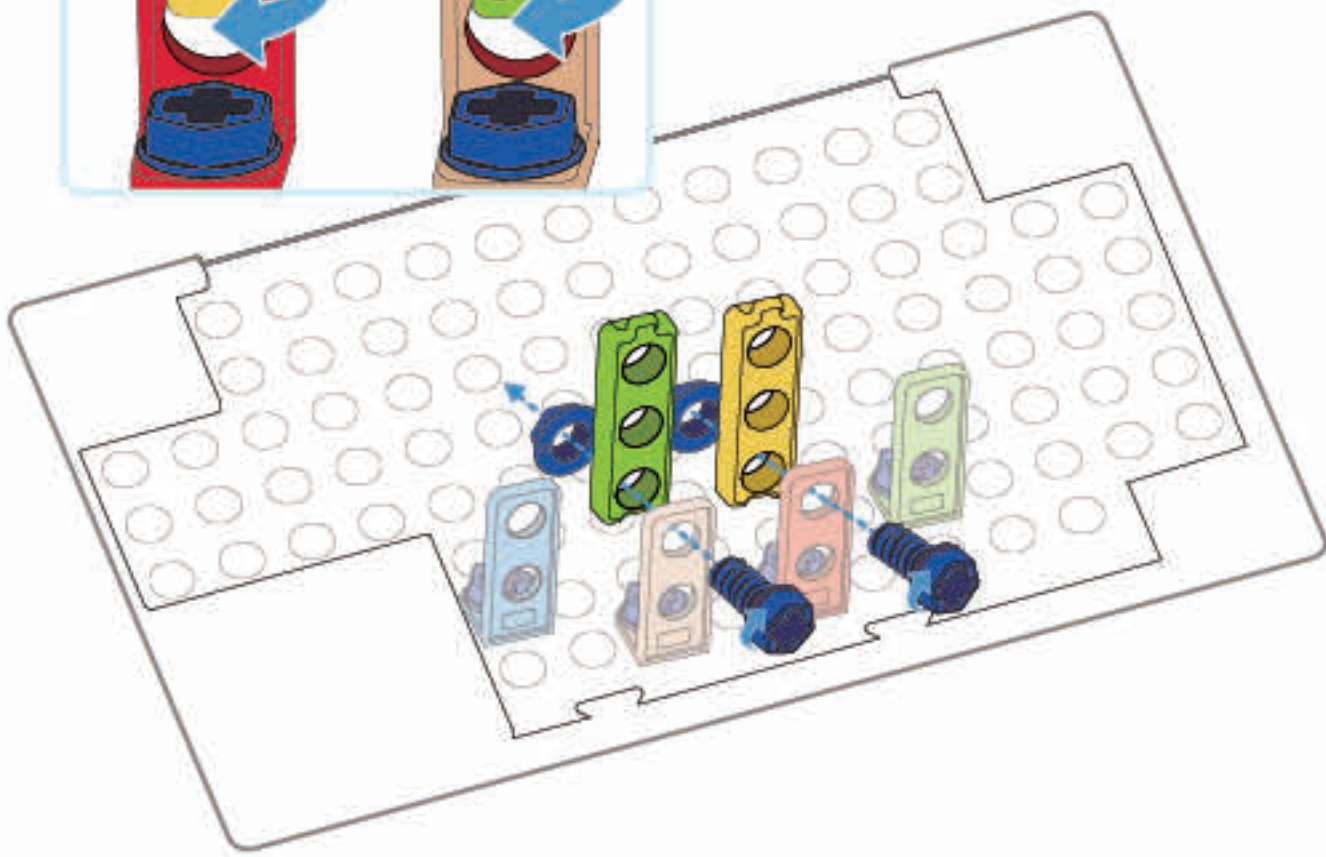

3

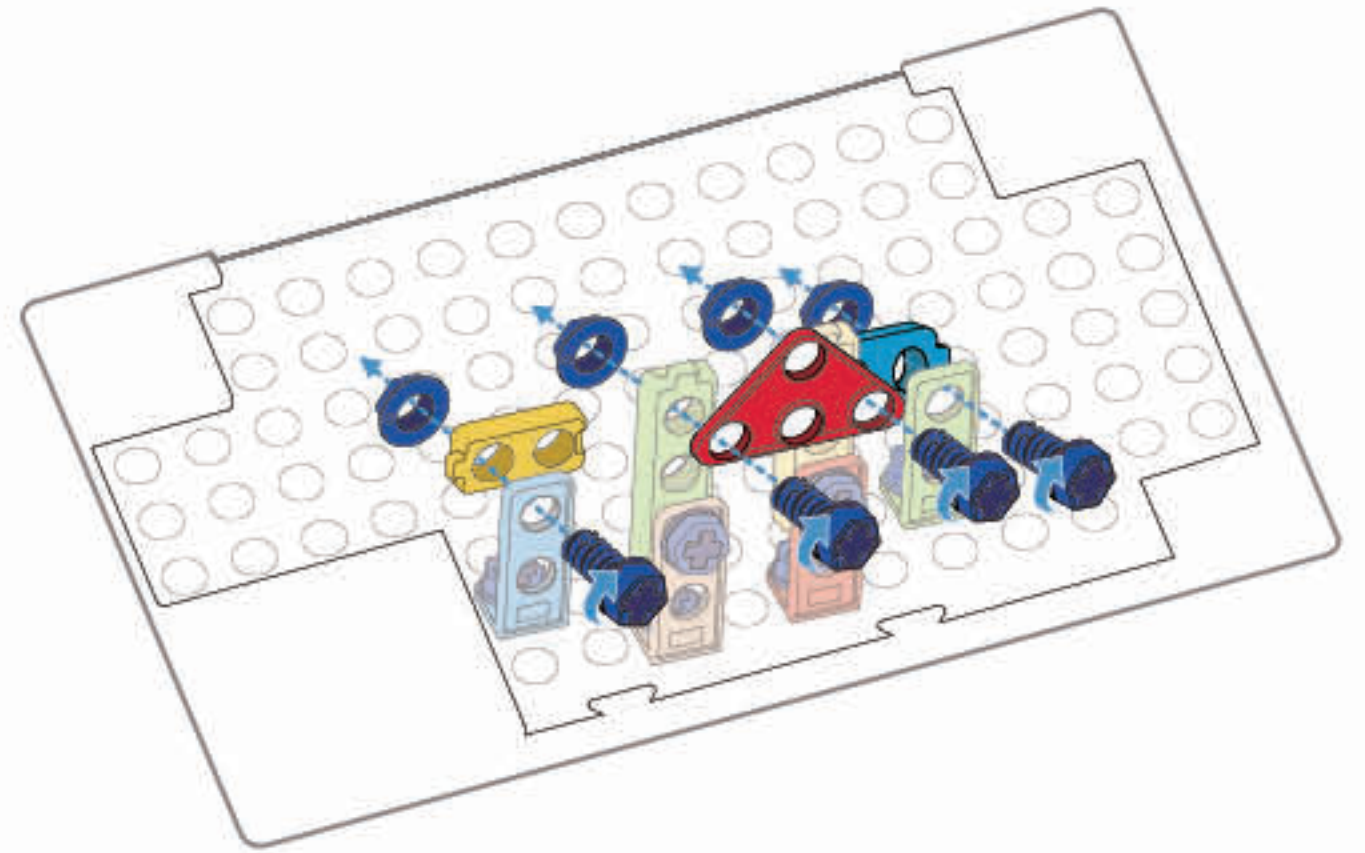
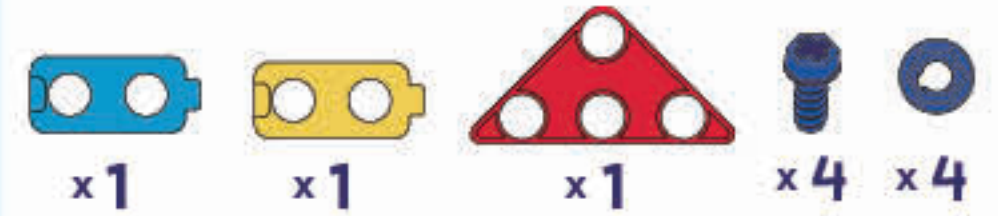

Well done!  
You made it!





013

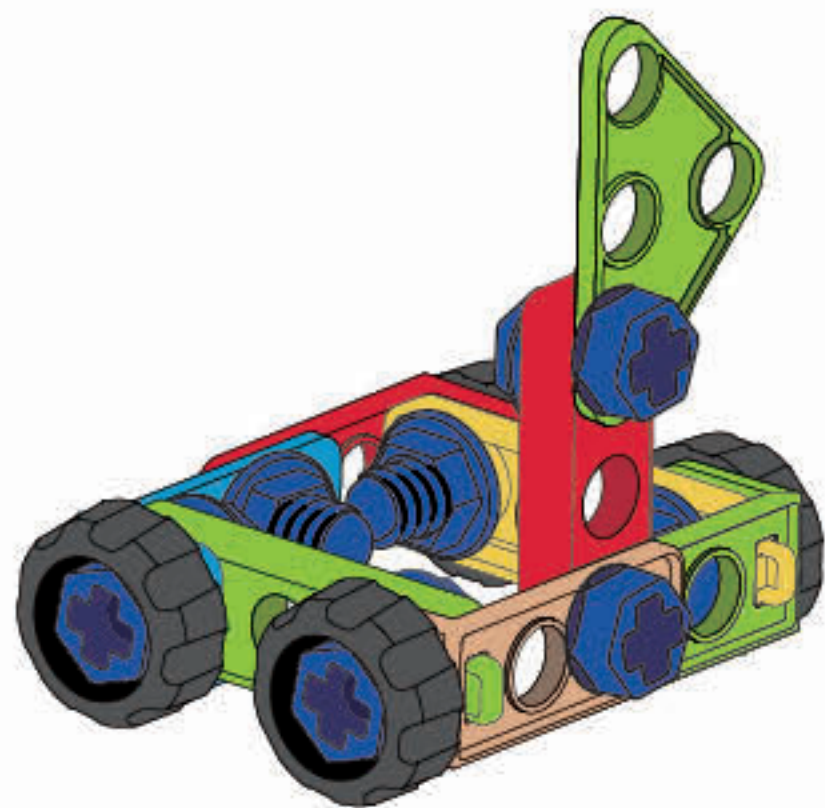
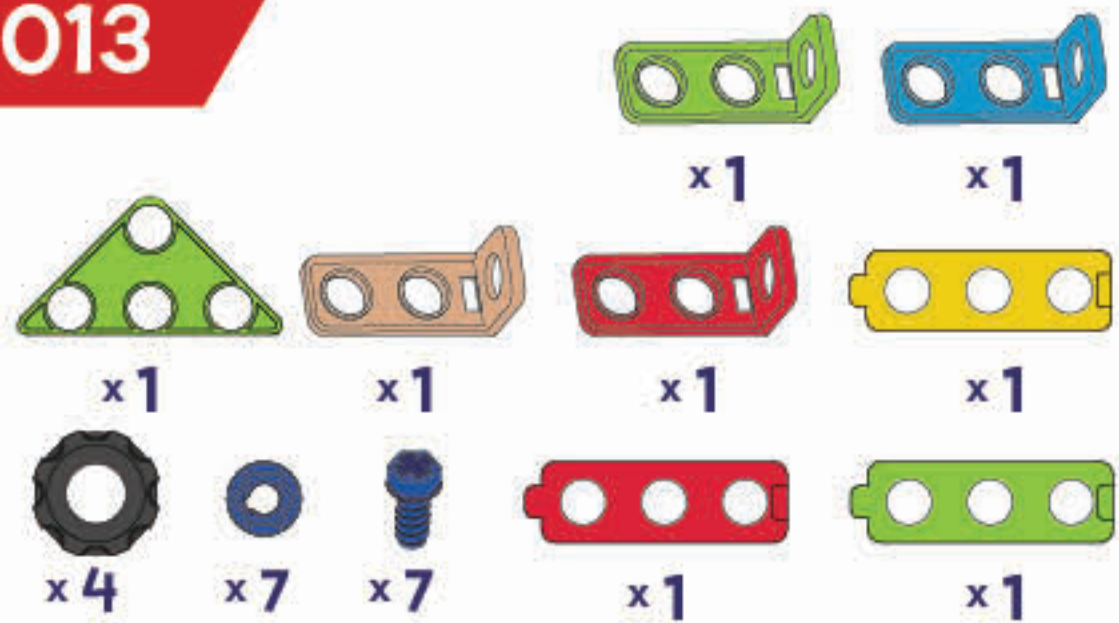

1

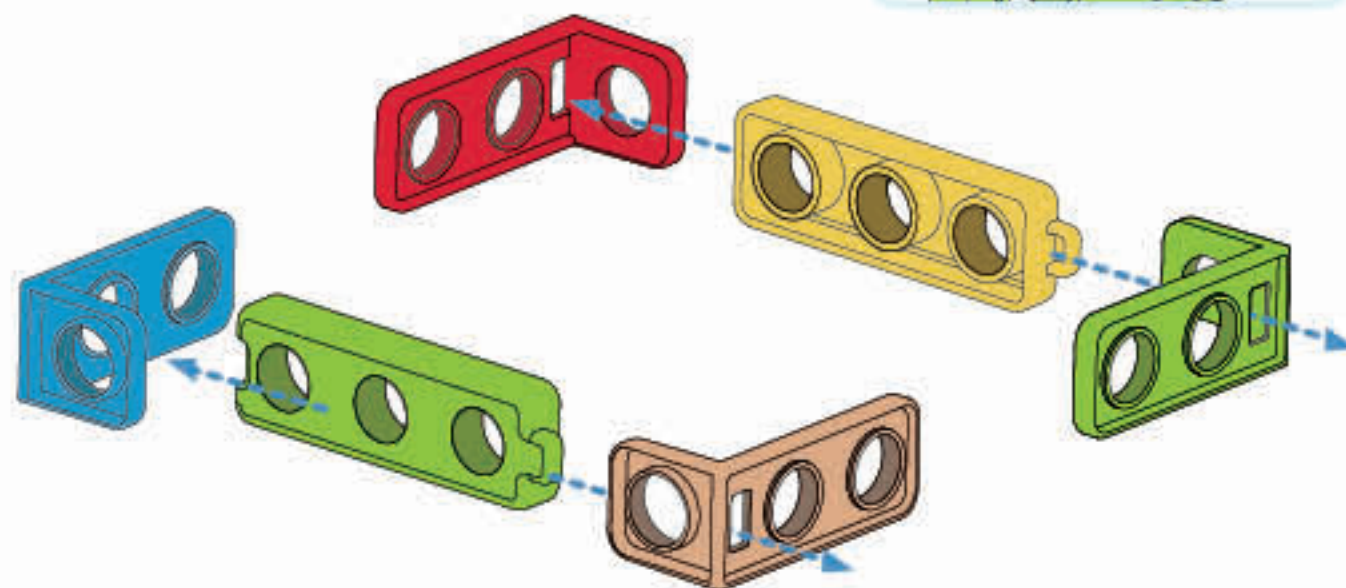
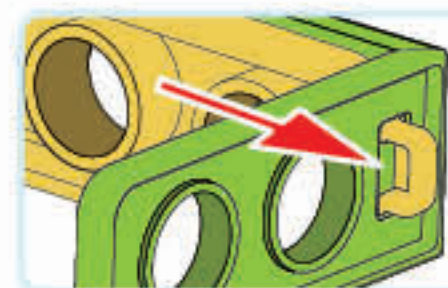
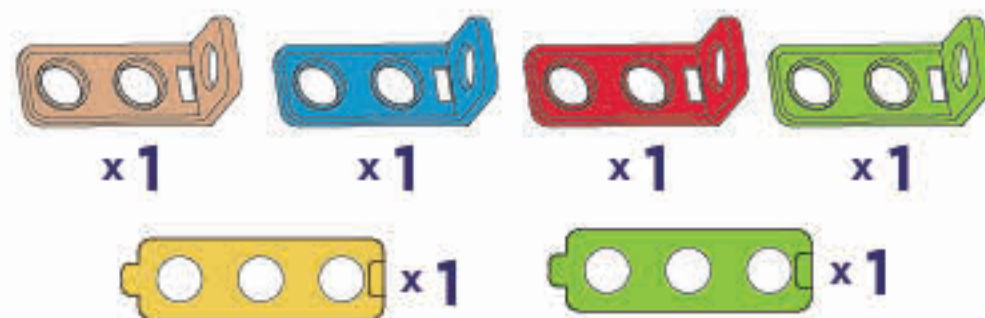

2

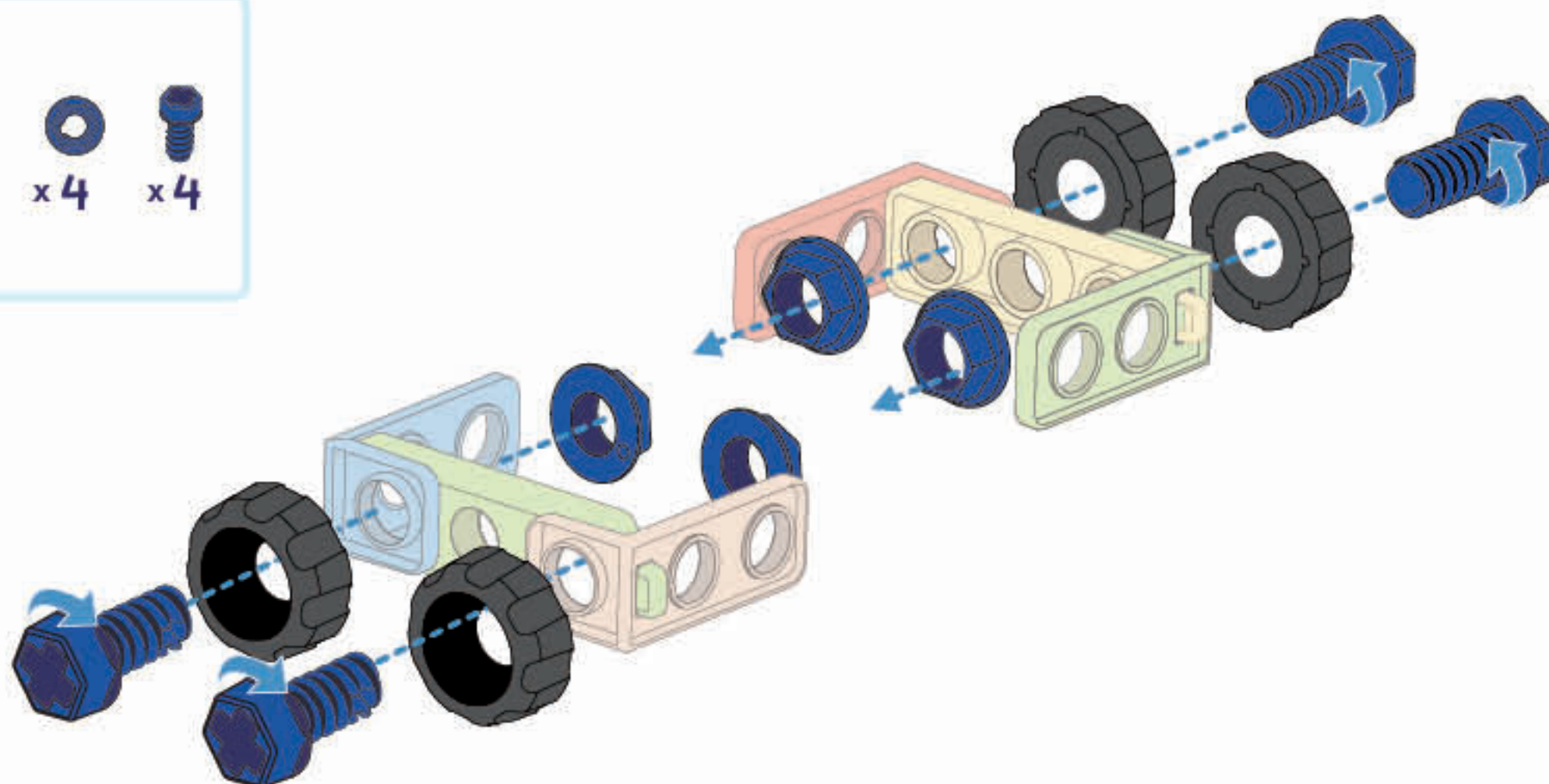

3

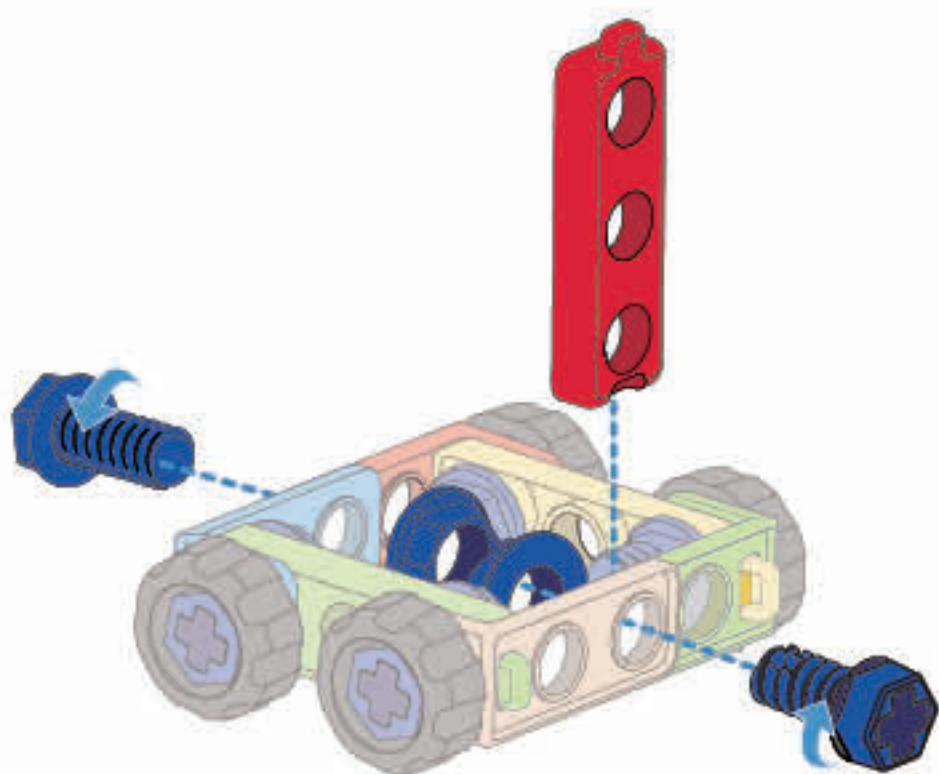
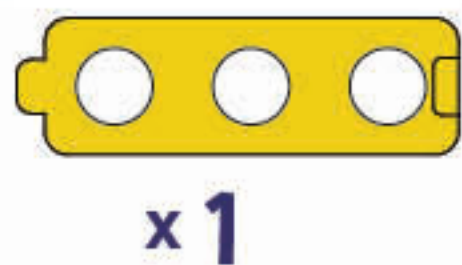

4

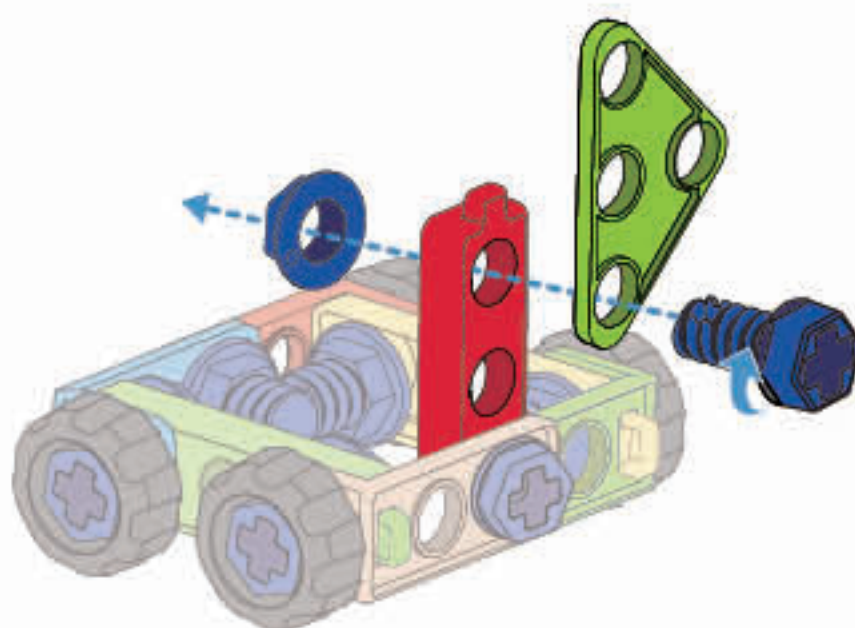

Well done!  
You made it!





014



x1

x1

x1



x4



x2

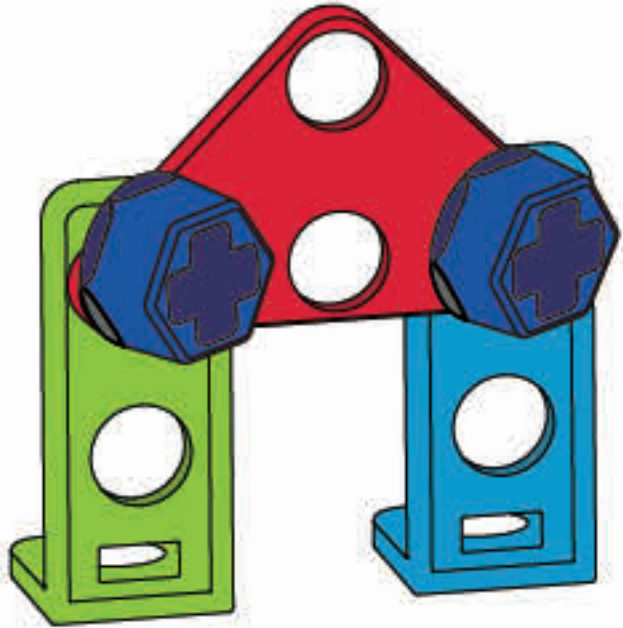

1



x2



x1



x1



Top View

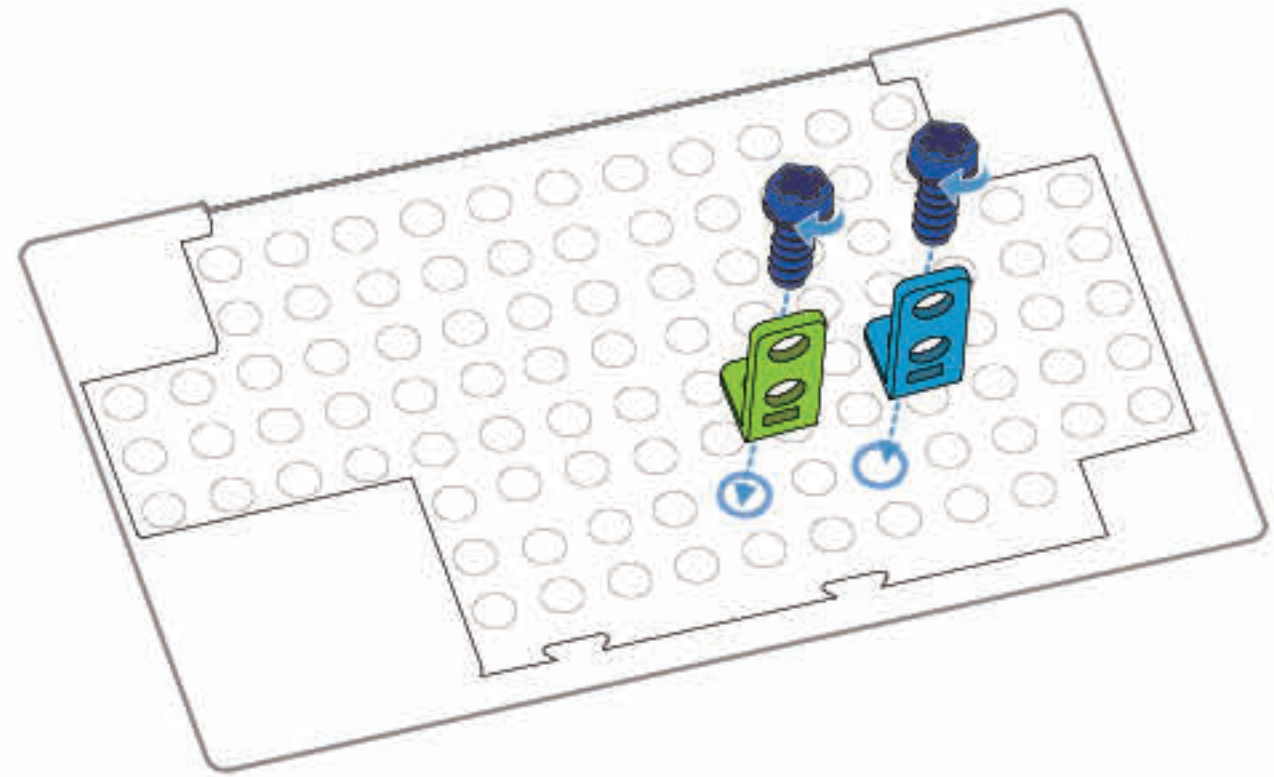

2



x1



x1



x2



x2



Top View

Back

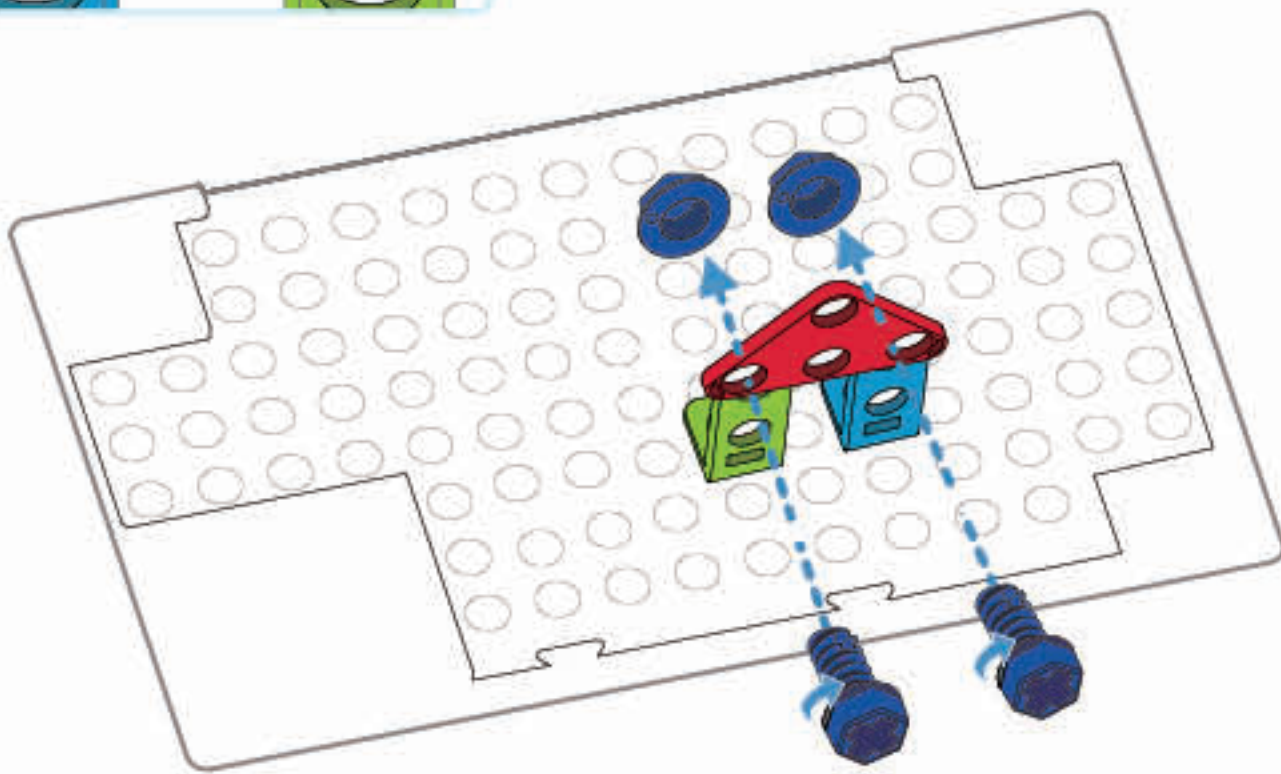

Well done!  
You made it!





015

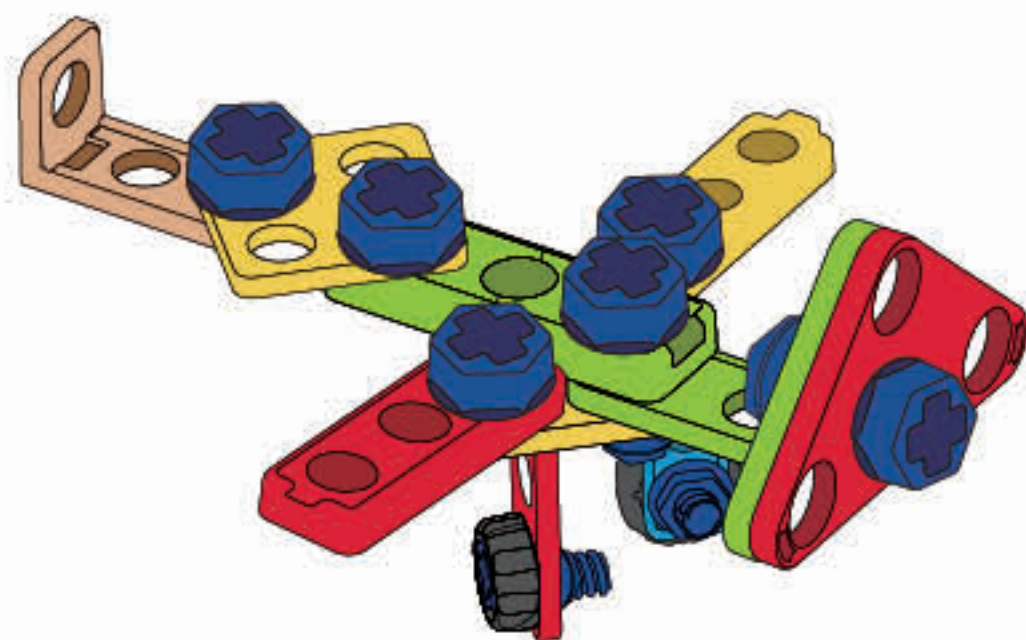
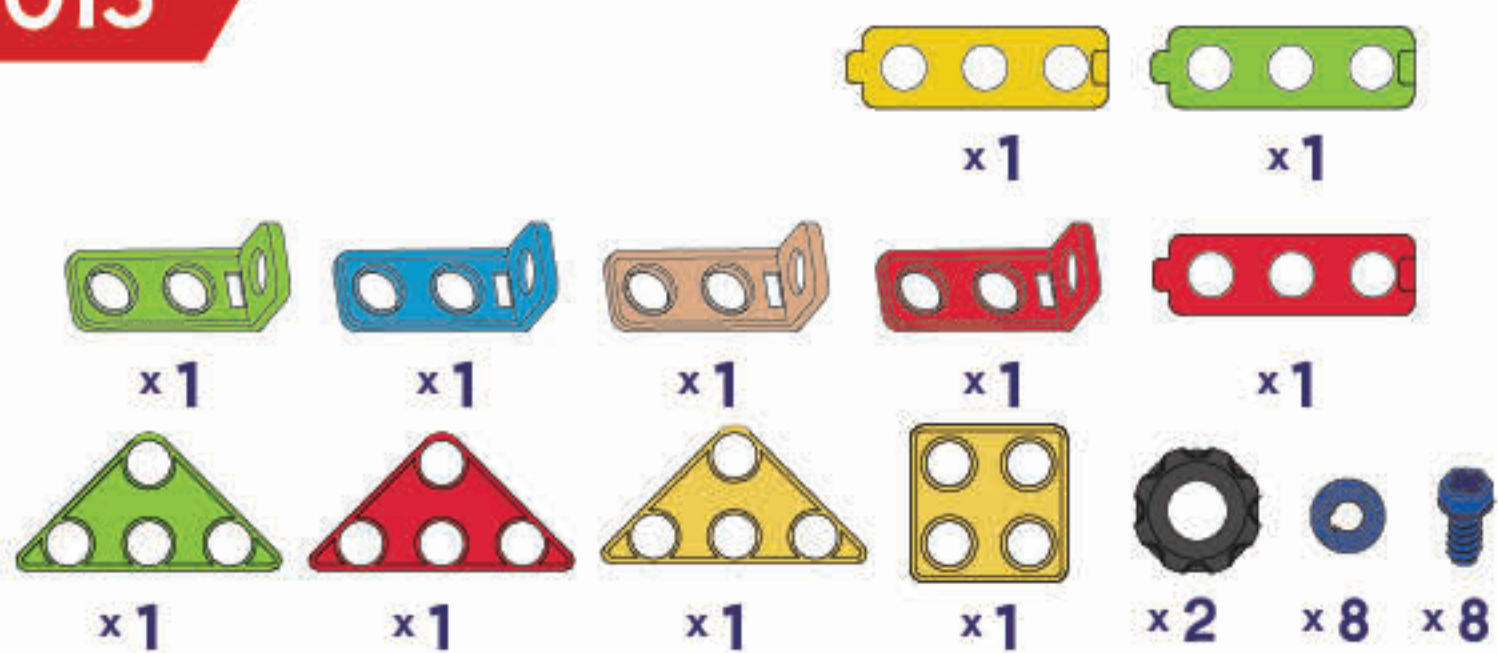

1

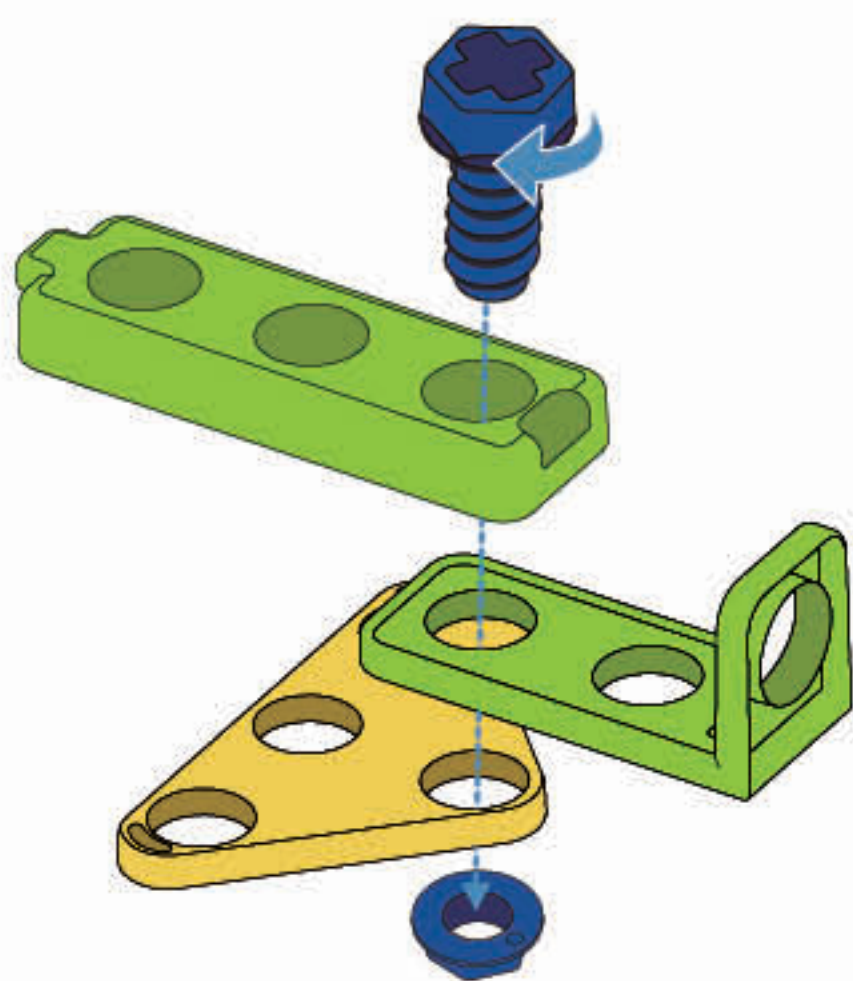

2

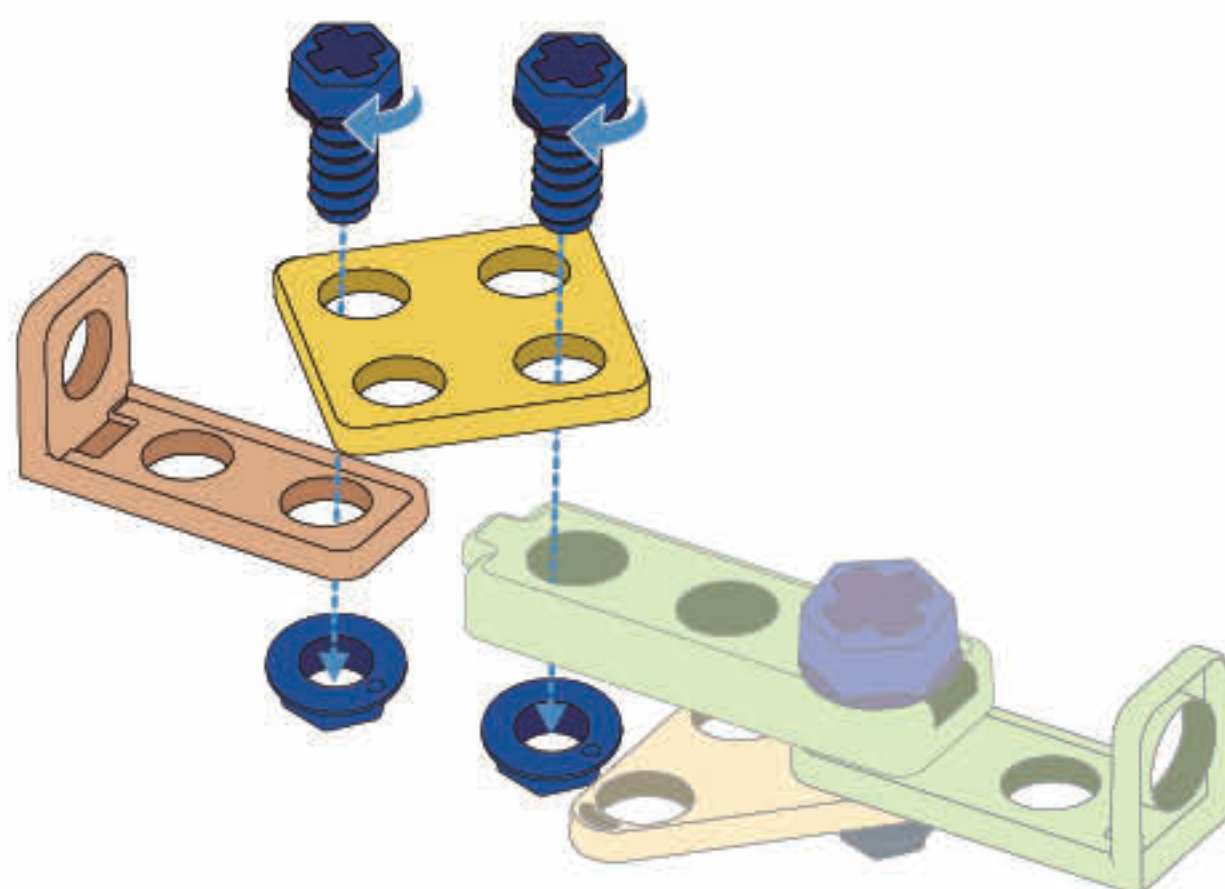
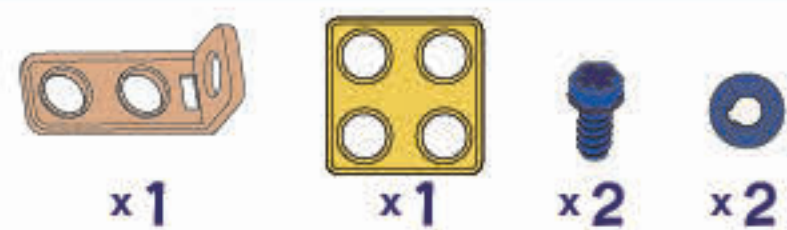

3

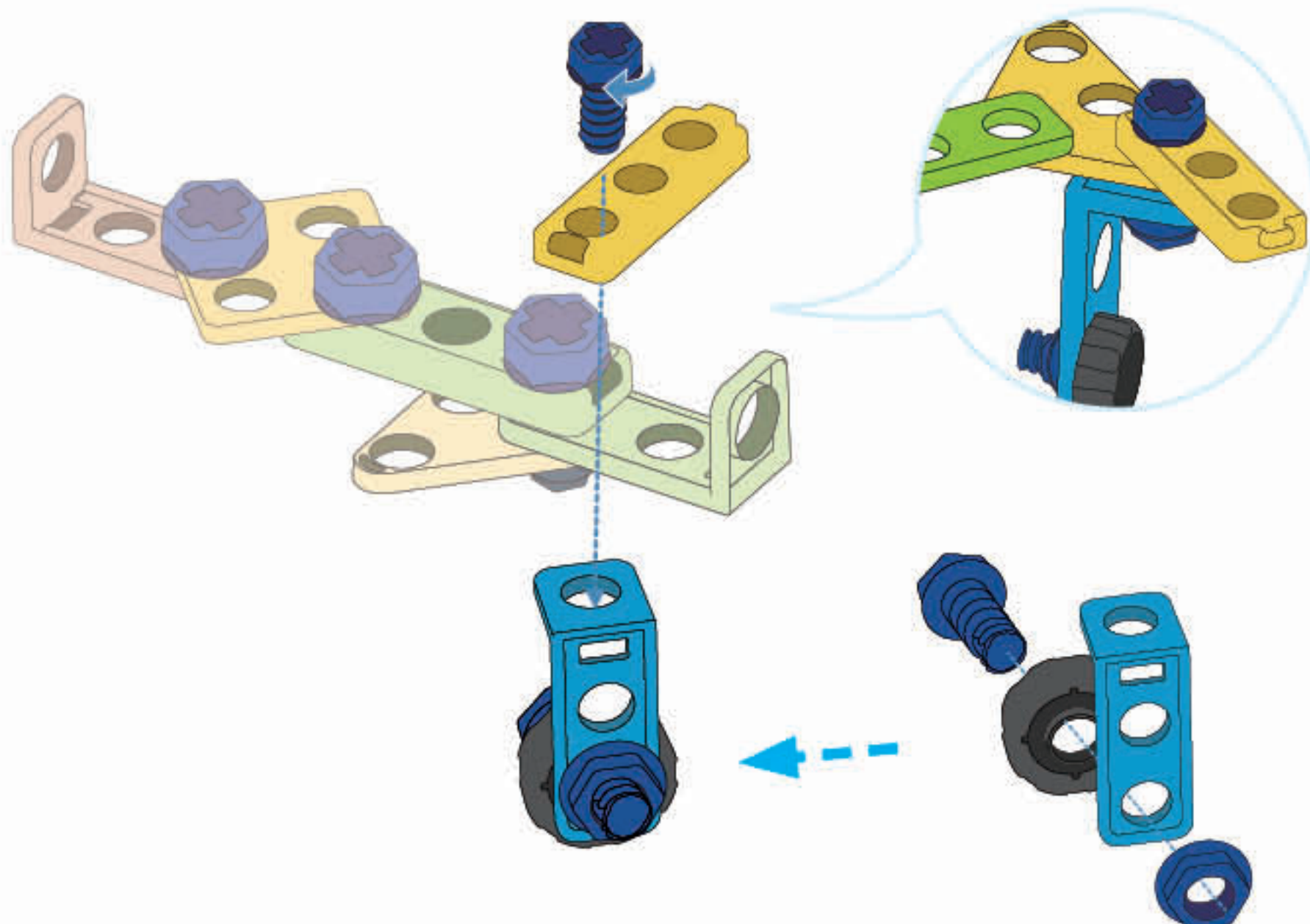
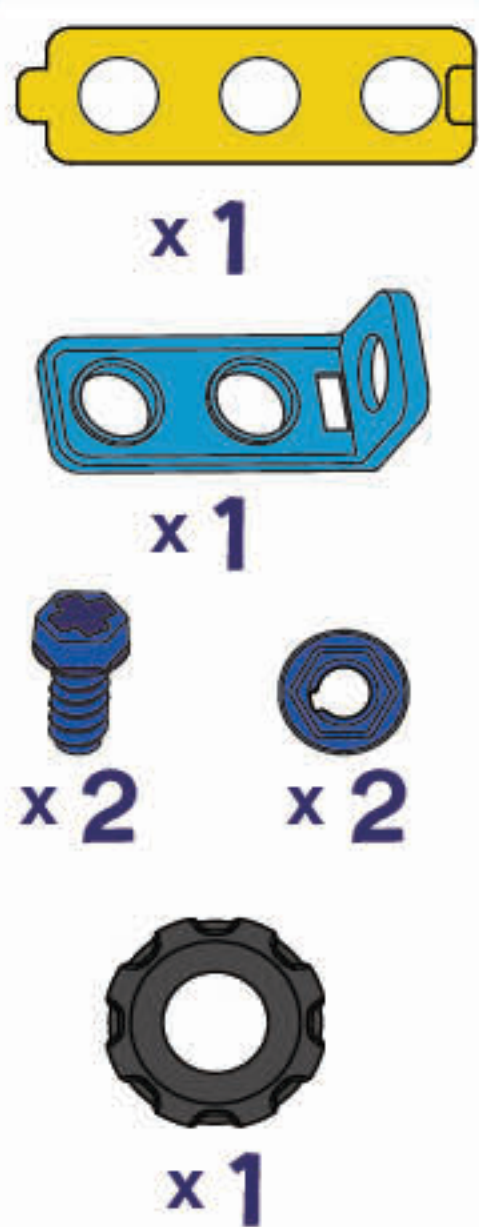



4



x 1



x 1



x 2



x 2



x 1

Back

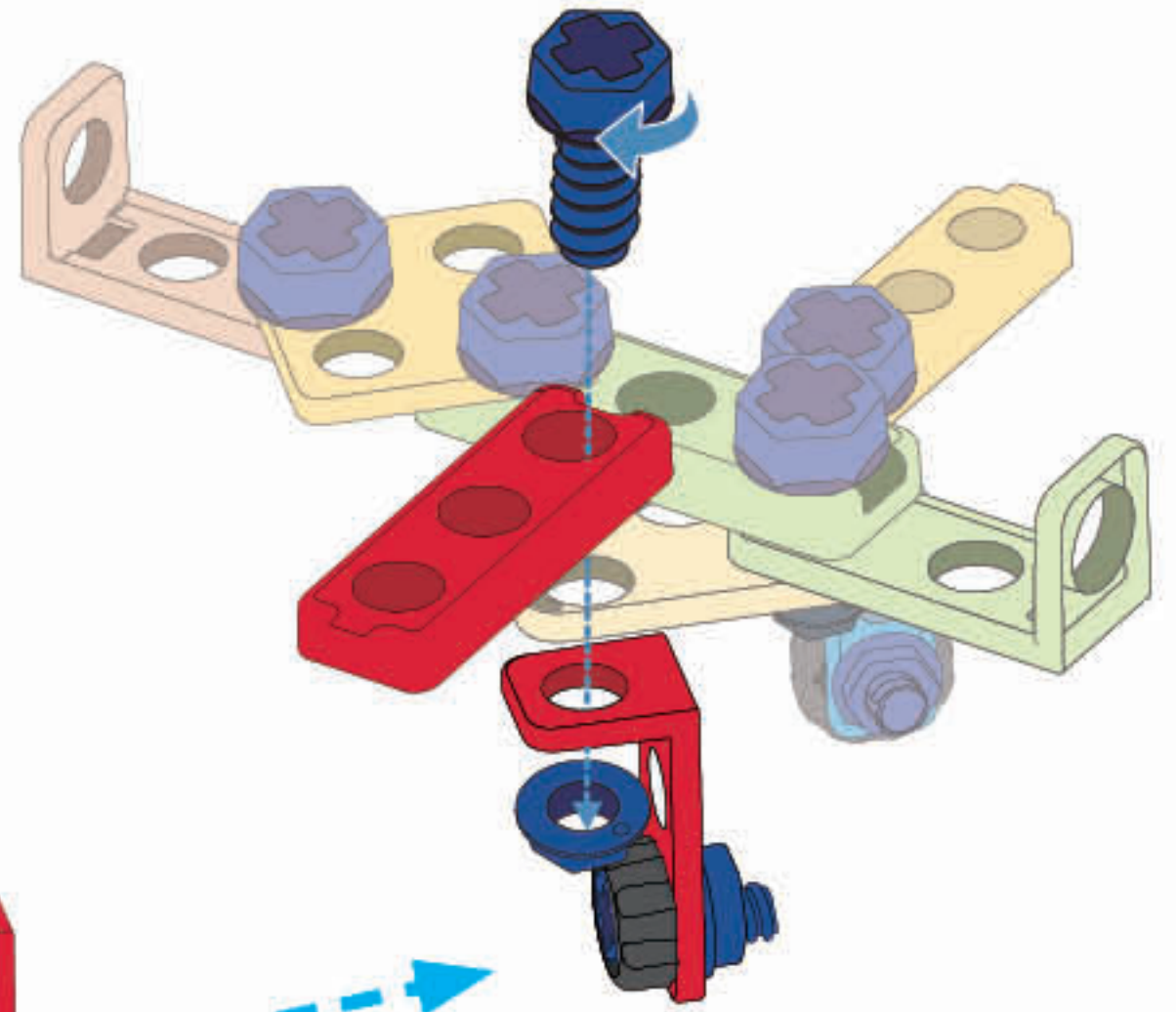
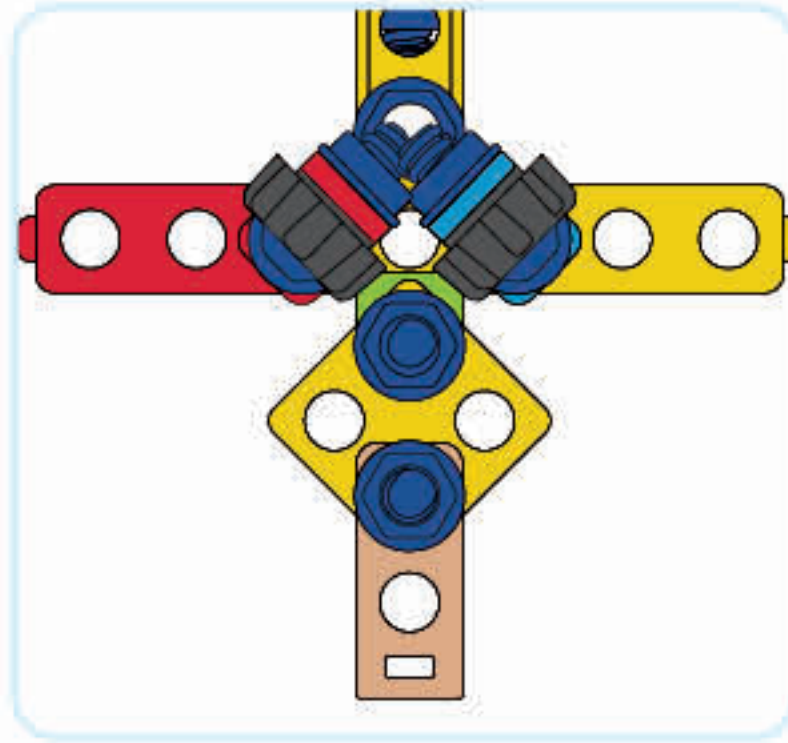

5



x 1

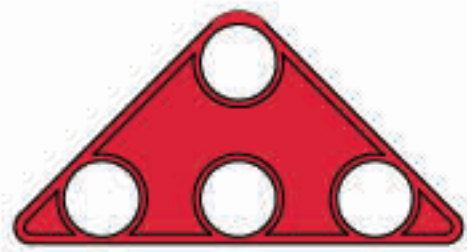

x 1



x 1



x 1

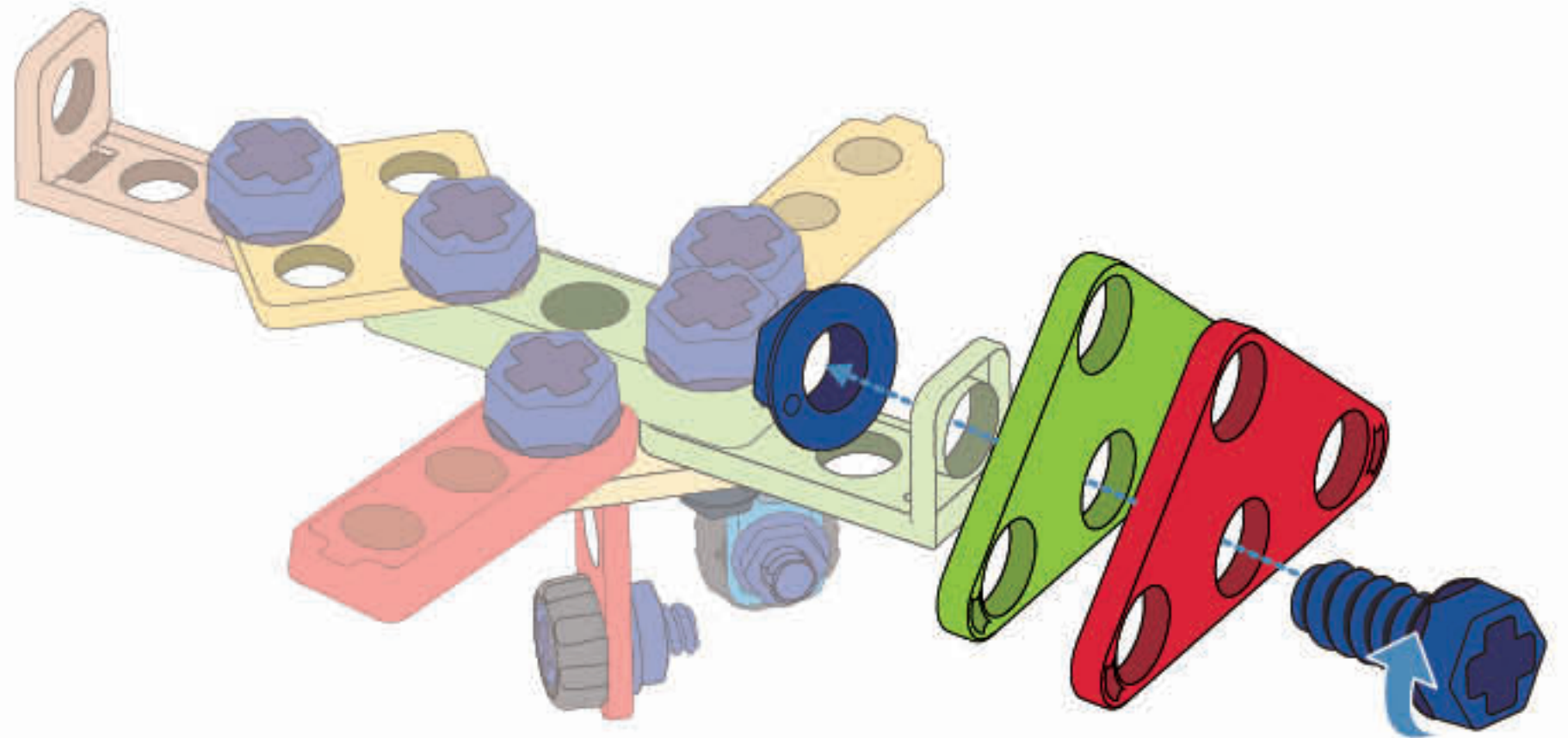

Well done!  
You made it!

